

Vordere Mitte Stoffbruch Fadenlauf/ Centre front fold straight grain/ Milieu endroit pli droit fil/ Middenvoor stofvouw draadrichting

Anstosslinie/ Joining line/
Jonction/ Aansluitlijn

0

Anstosslinie/ Joining line/
Jonction/ Aansluitlijn

10 x 10 cm

3" x 3"

1,0

1,5

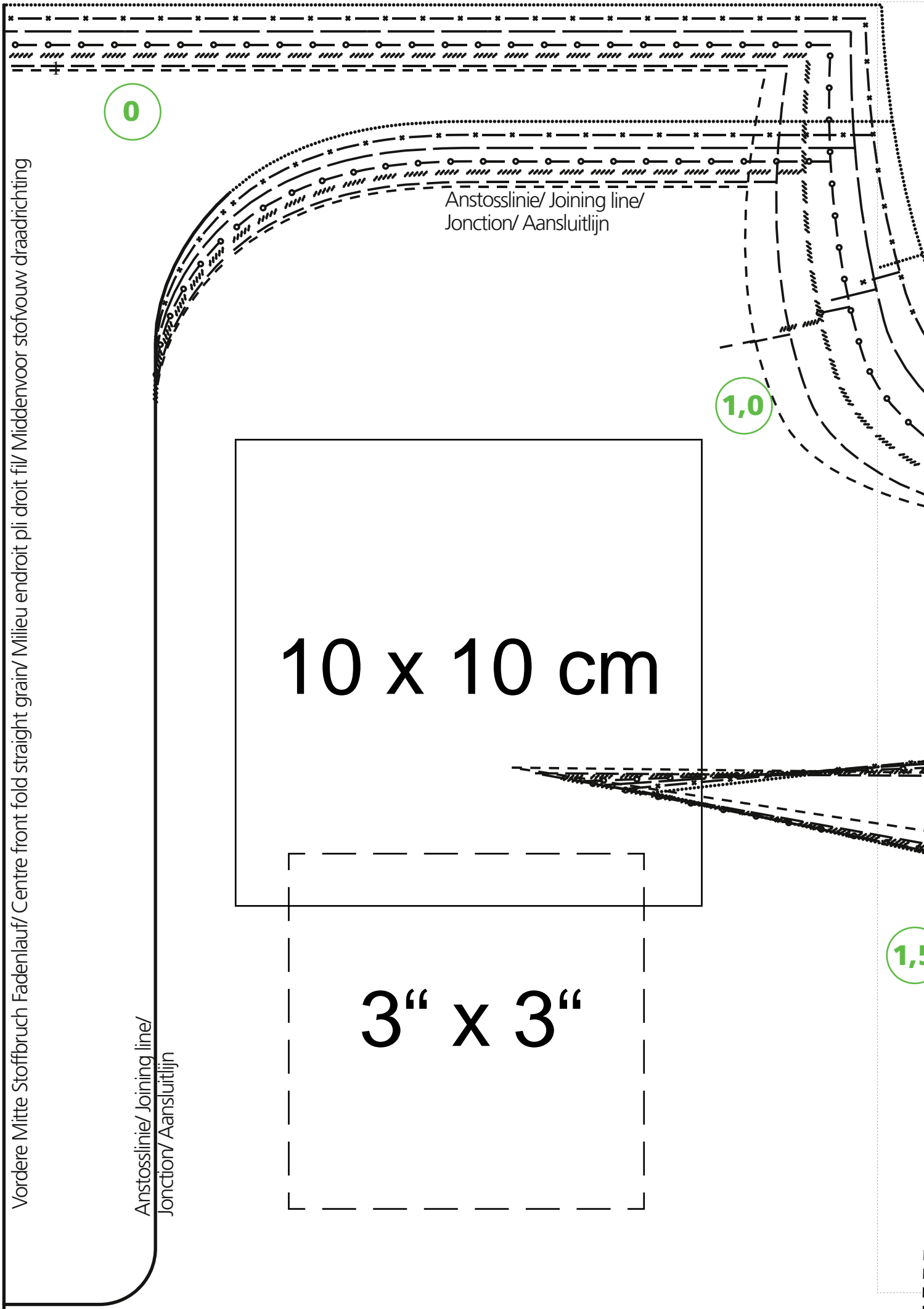

2

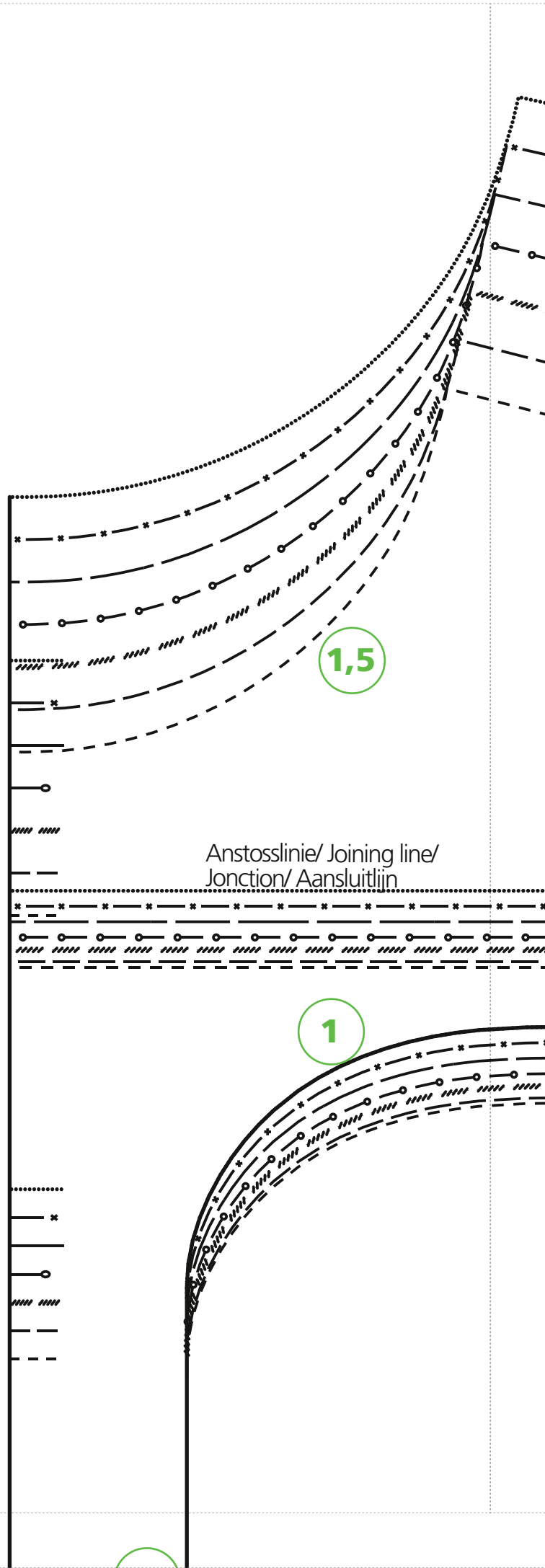
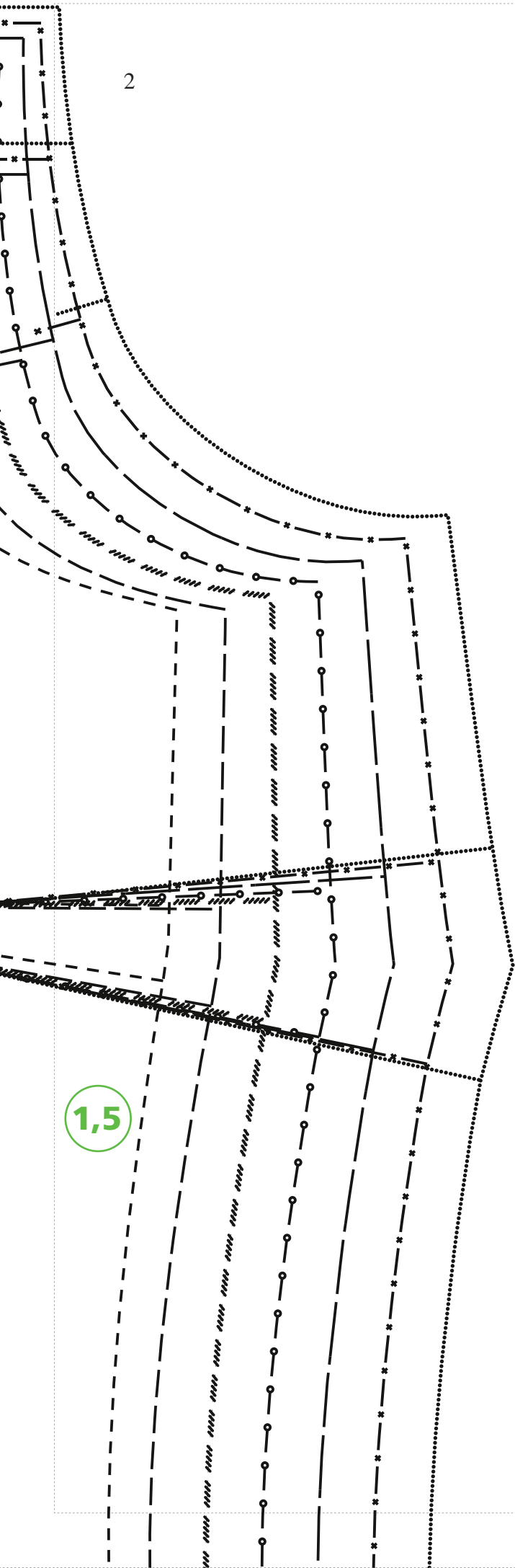

Anstosslinie/ Joining line/
Jonction/ Aansluitlijn

3



1,5

1,0

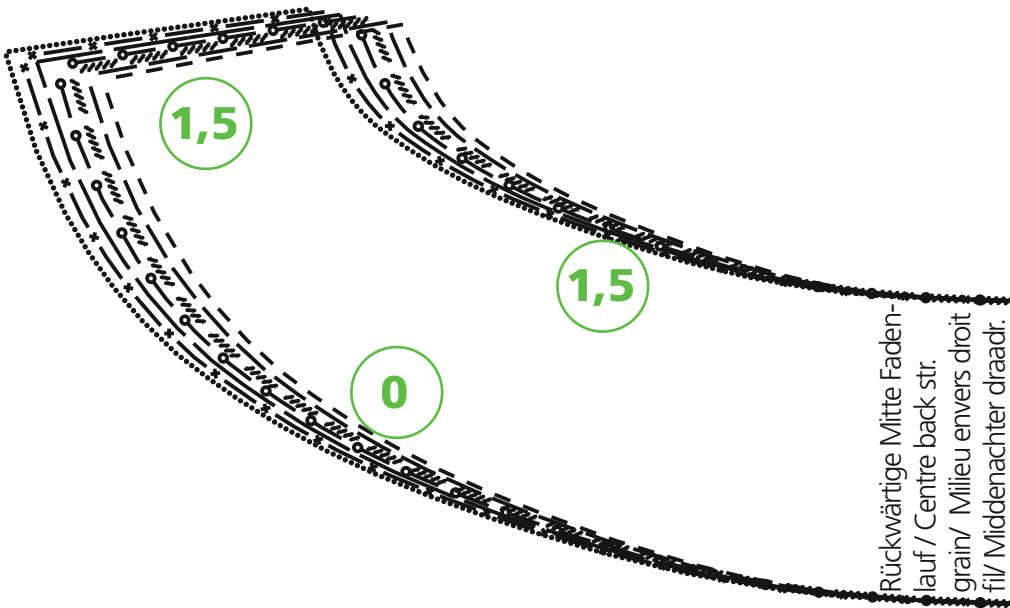
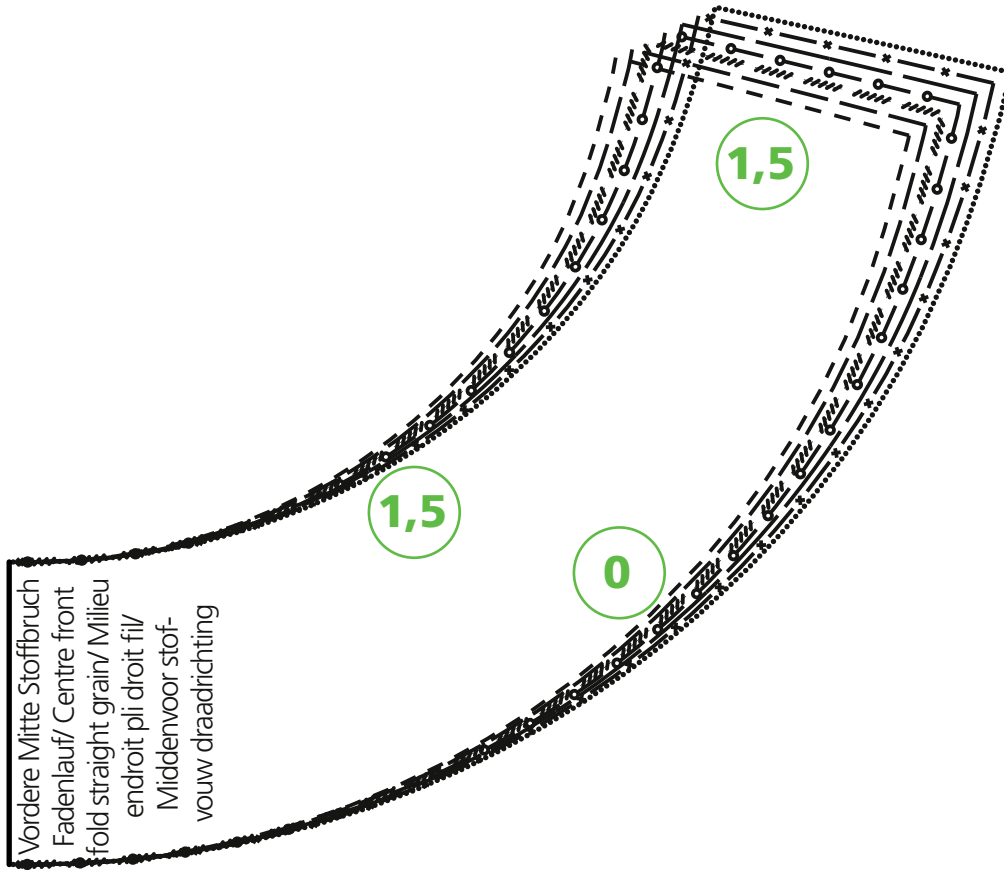

Ansatz Tasche/ Pocket placement/
Rabat poche/ Plaatsing zak

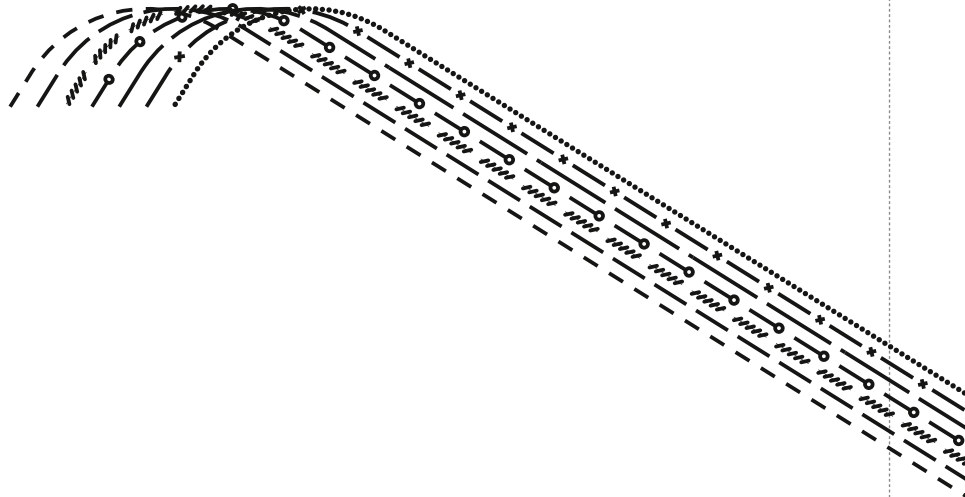

Für Körpergröße/ for height/ pour la taille/ Maten voor lichaamsgrootte 168 cm								
Größe/ Size/ Taille/ Maat	34	36	38	40	42	44	46	48
Oberweite/Bust/ Poitrine/ Bovenwijdte	80	84	88	92	96	100	104	110
Taillenweite/ Waist/ Taille/ Taille-wijdte	64	67	71	75	79	83	87	93
Hüftweite/ Hip/ Hanche/ Heupwijdte	90	93	96	99	102	105	108	114
Vord. Taillengl./ Front waist length/ Longueur taille devant/ Taillelengte voor	42	43	44	45	46	47	48	49
Rückw. Taillengl./ Back waist length/ Longueur taille dos/ Ruglengte tot taille	41	41	41	42	42	42	42	43

Legende/ Legend/ Légend		
Größe/	---	34
Size/	---	36
Taille/	---	36
Maat	////	38
	—○—○—○—○	40
	---	42
	— * — * — *	44
	46
	————	48



1

Vordere Mitte Stoffbruch Fadenlauf/
 Centre front fold straight grain/ Milieu
 endroit pli droit fil/ Middenvoor stofvouw draadrichting

1

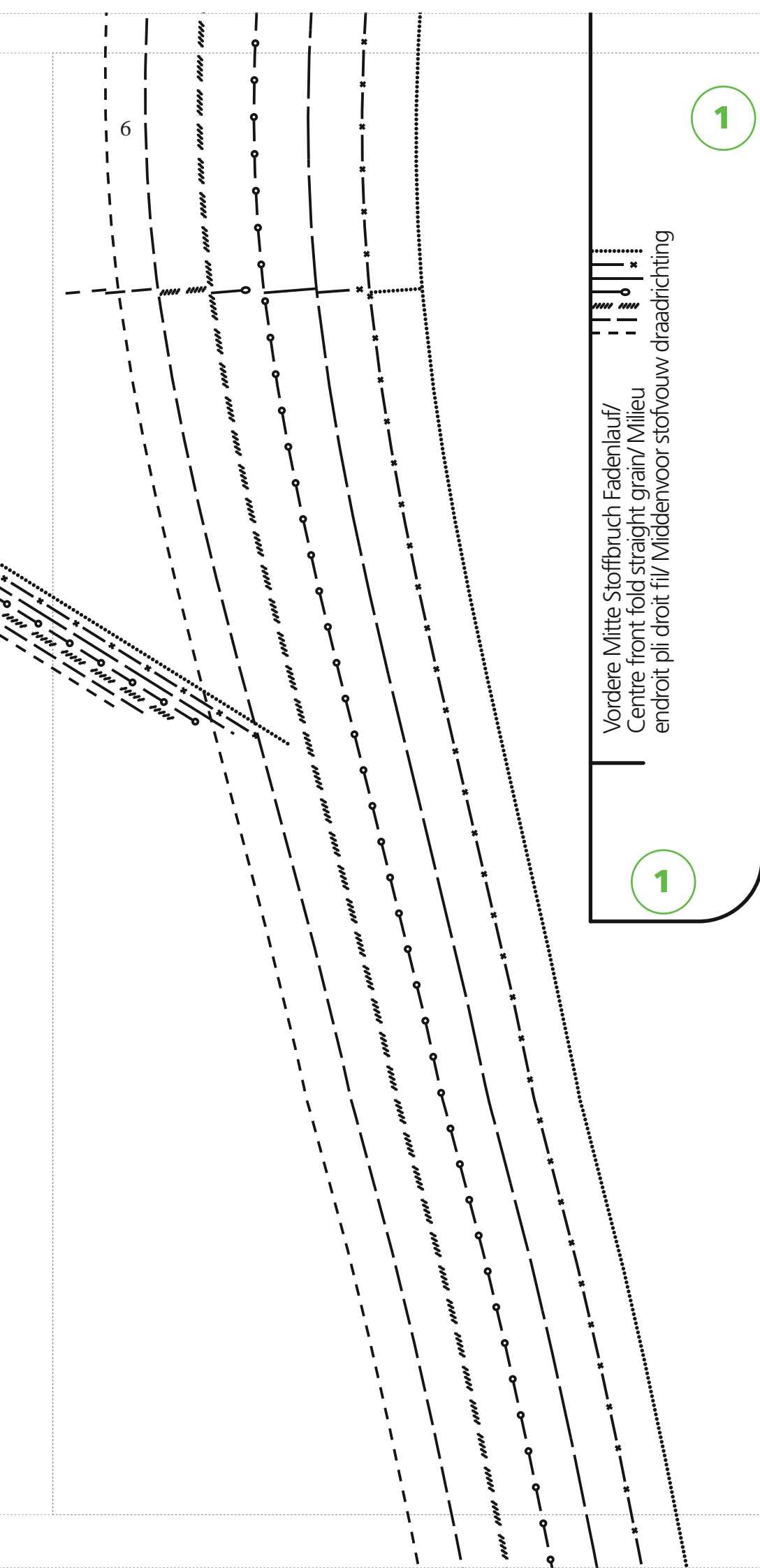

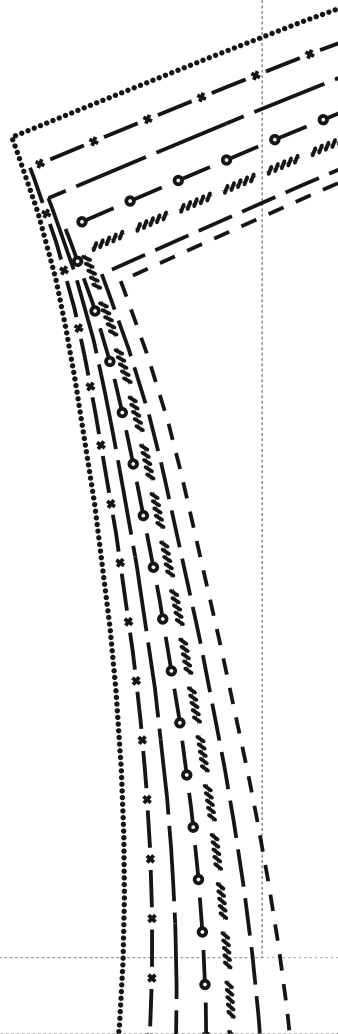
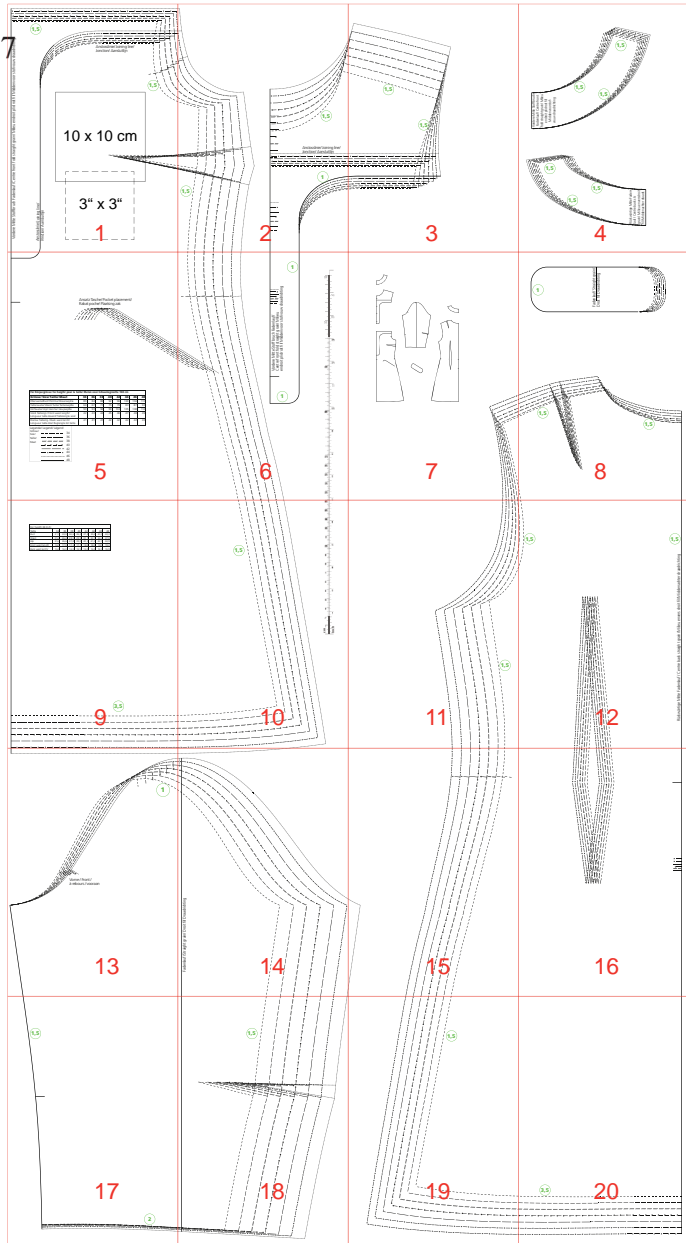

8

1

Fadenlauf/ Straight grain/
Droit fil/ Draadrichting

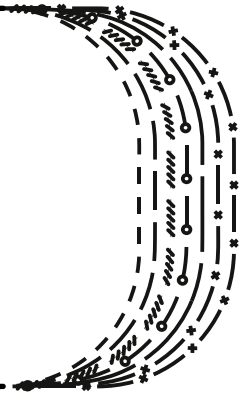

1,5

1,5

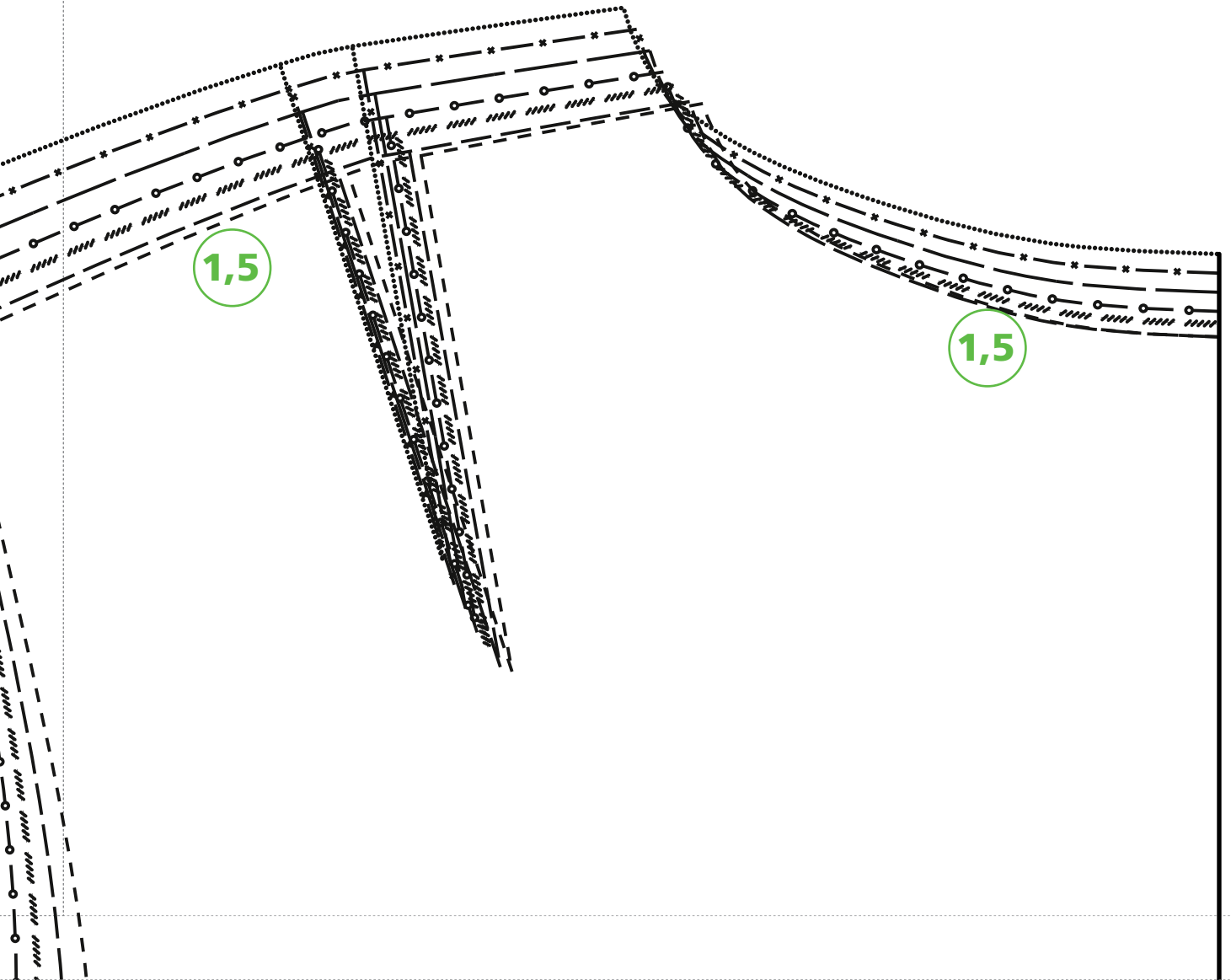

For heigth 66 Inch:								
Taille	34	36	38	40	42	44	46	48
Bust	31,5	33,0	34,6	36,2	37,8	39,4	40,9	43,3
Waist	25,2	26,4	28,0	29,5	31,1	32,7	34,3	37,0
Hip	35,4	36,6	37,8	39,0	40,2	41,3	42,5	44,9
Front waist length	16,5	17,0	17,3	17,7	18,0	18,5	18,9	19,2
Back waist lenth/	16,0	16,0	16,0	16,5	16,5	16,5	16,5	16,9

3,5

Handwriting practice lines consisting of a dashed top line, a solid middle line, and a dotted bottom line. The lines are filled with various patterns: a row of slanted lines, a row of circles, and a row of asterisks.

10

1,5

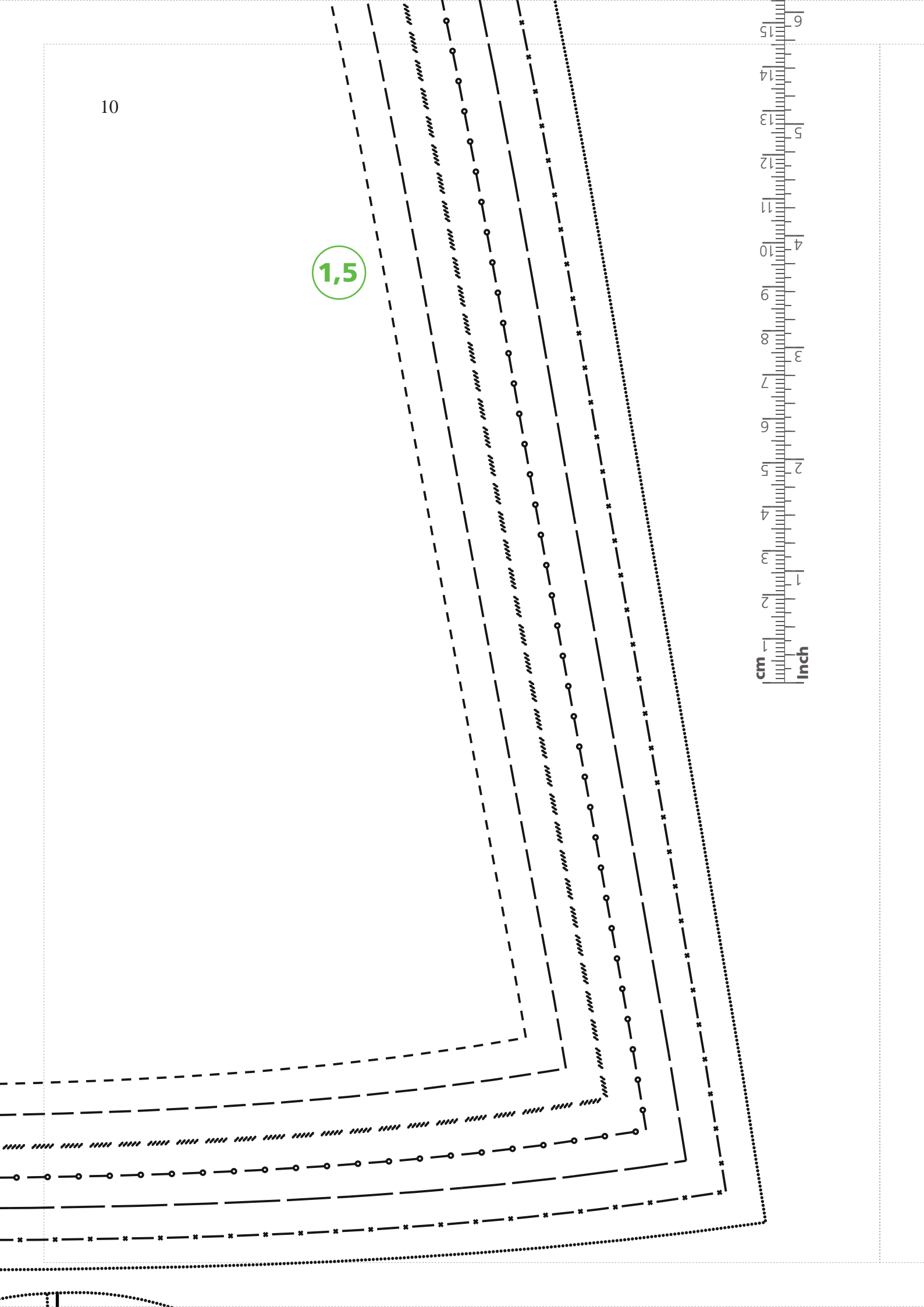

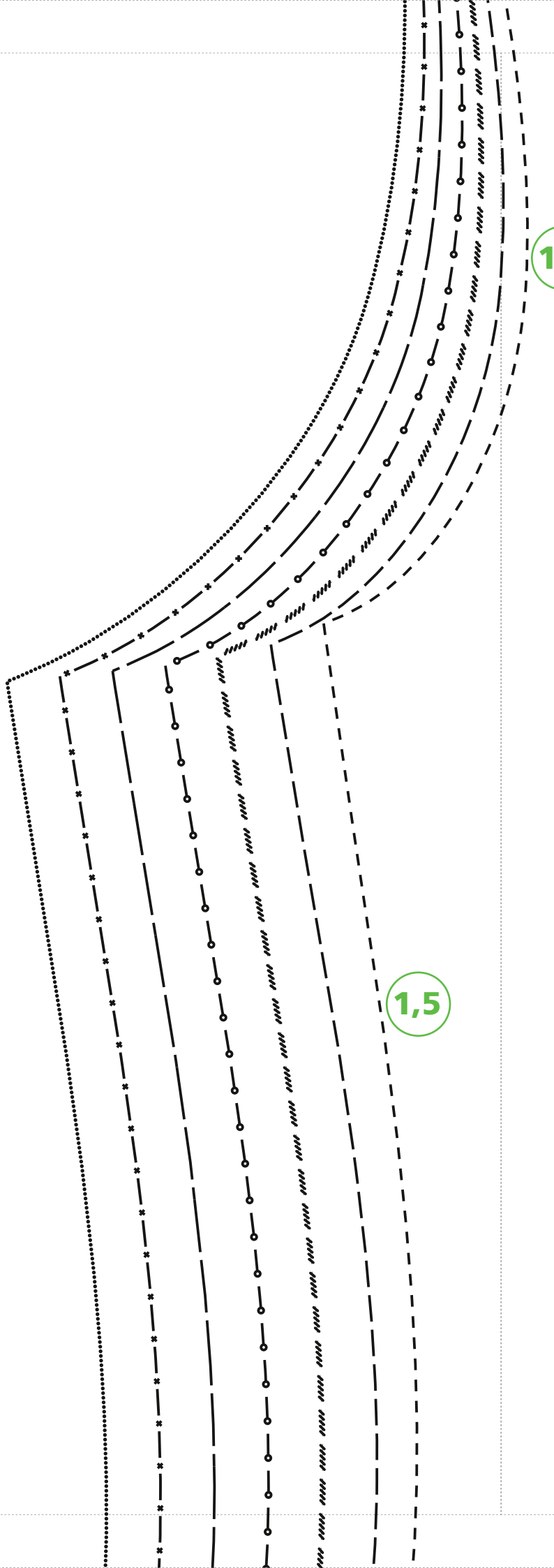

1,5

1

1,0

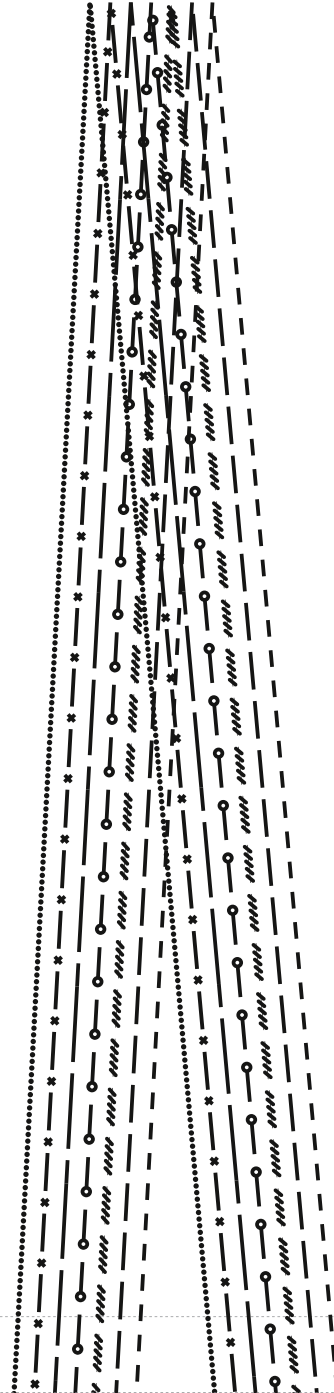

1,5

Rückwärtige Mitte Fadenlauf / Centre back straight grain / Milieu envers droit / Middenachter draadrichting

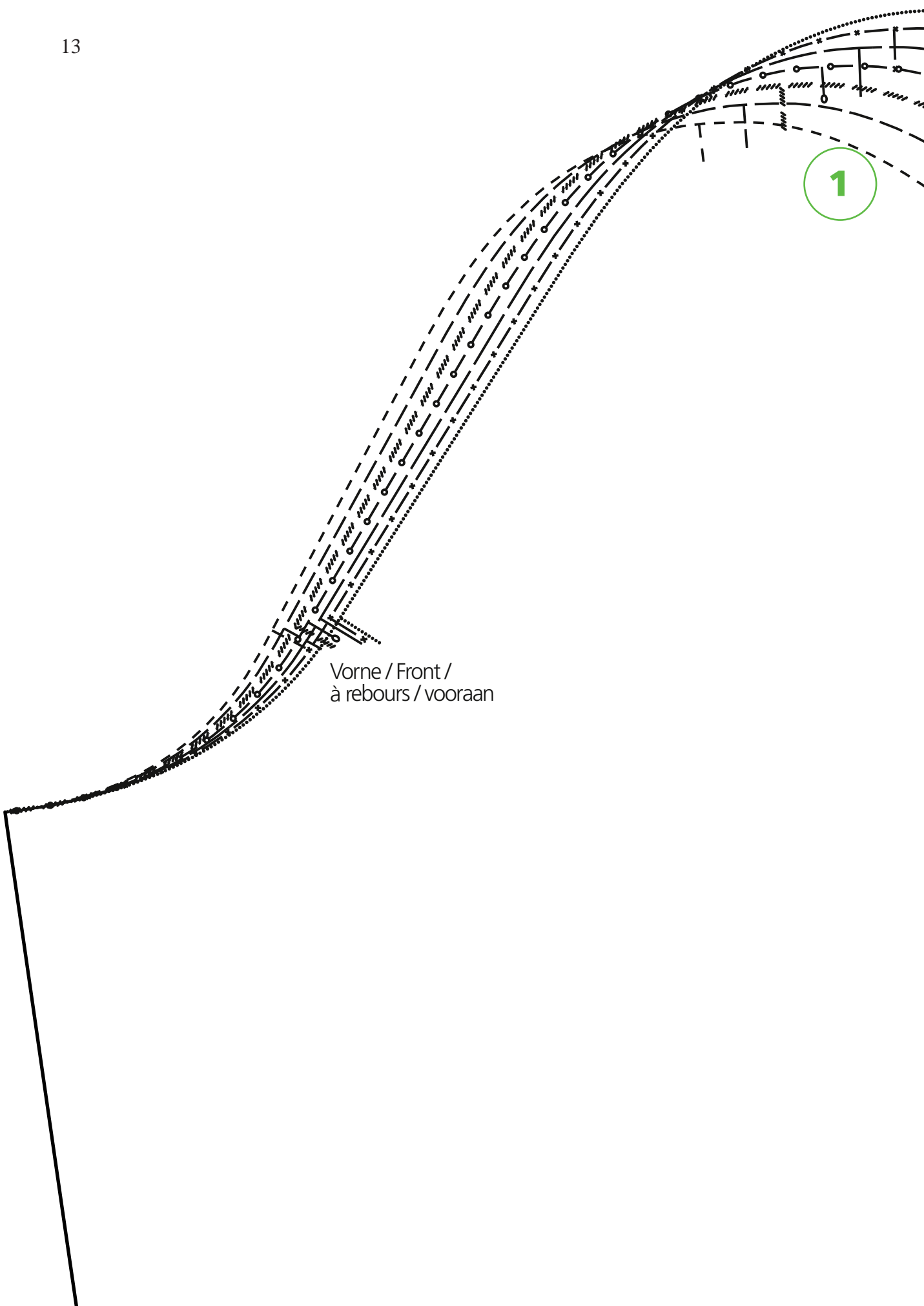

Vorne / Front /
à rebours / vooraan

Fadenlauf/ Straight grain/ Droit fil/ Draadrichting

14*

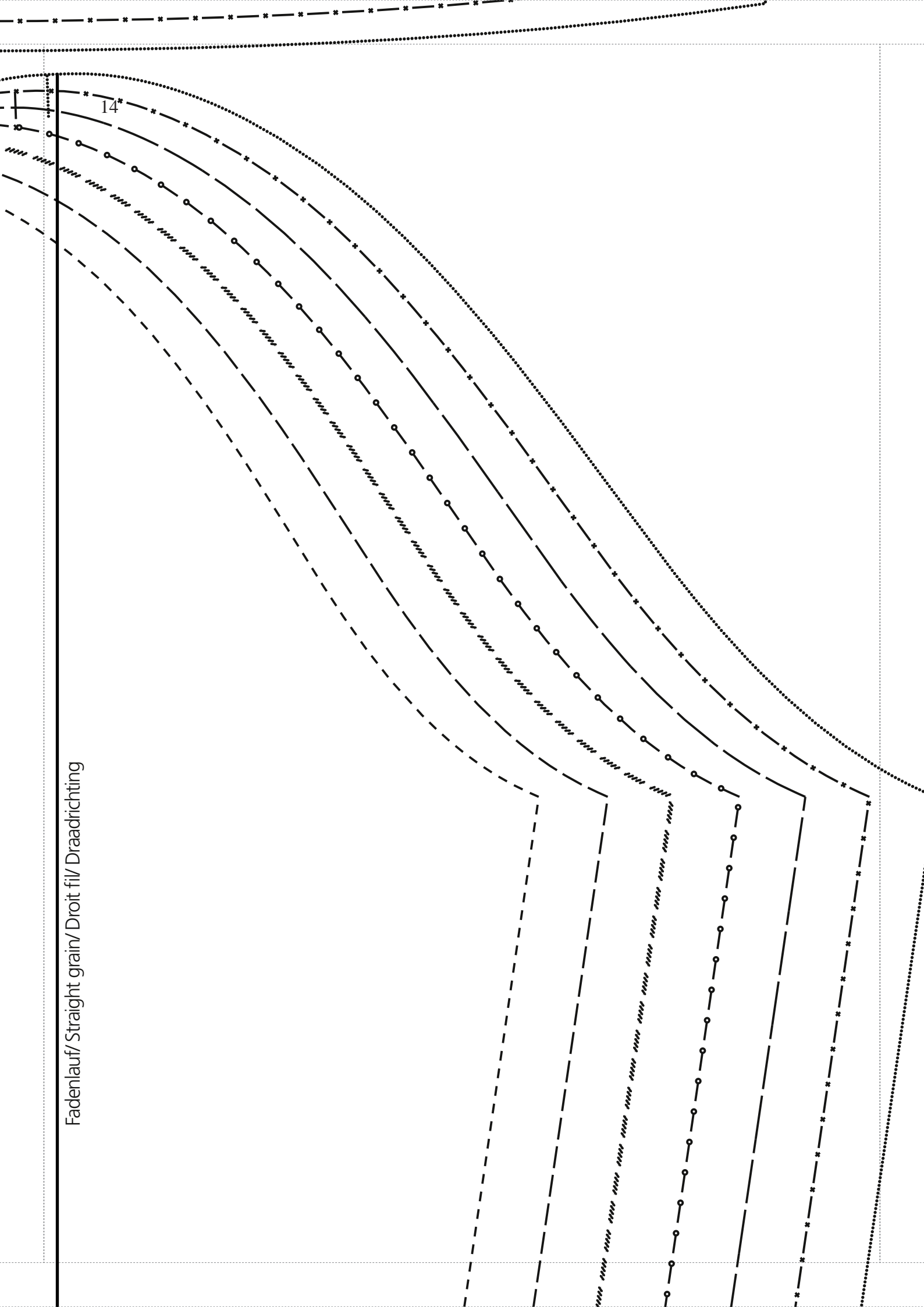

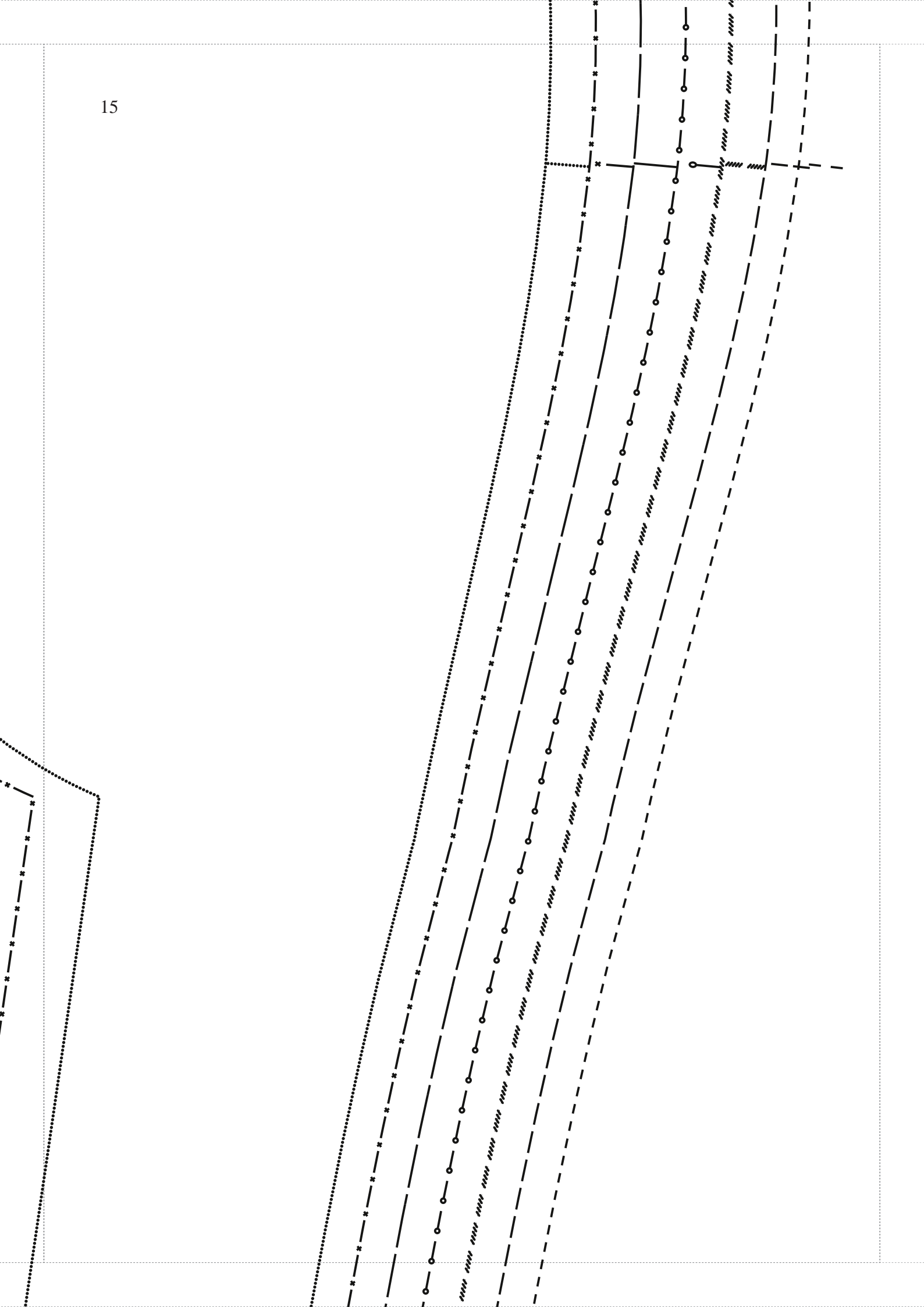

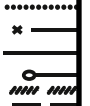
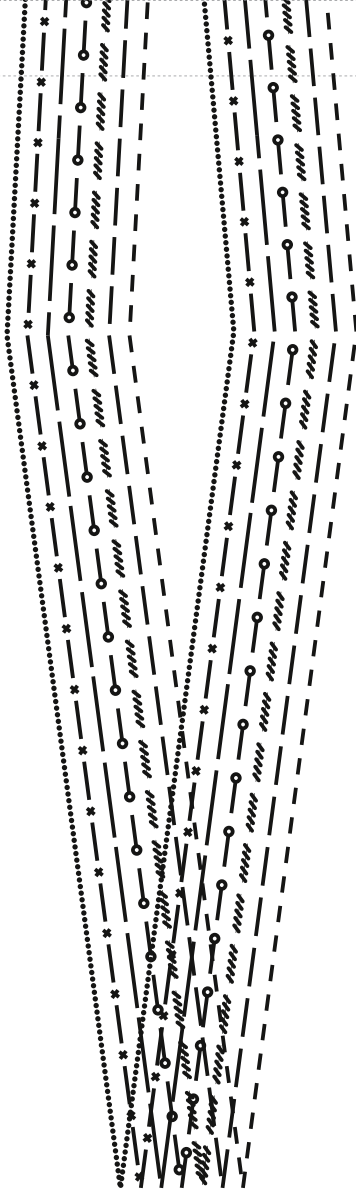

17

1,5



2

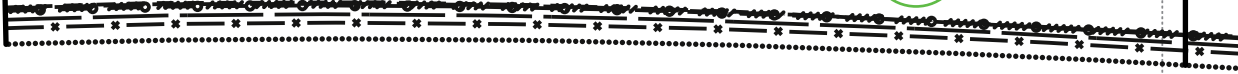

1,5

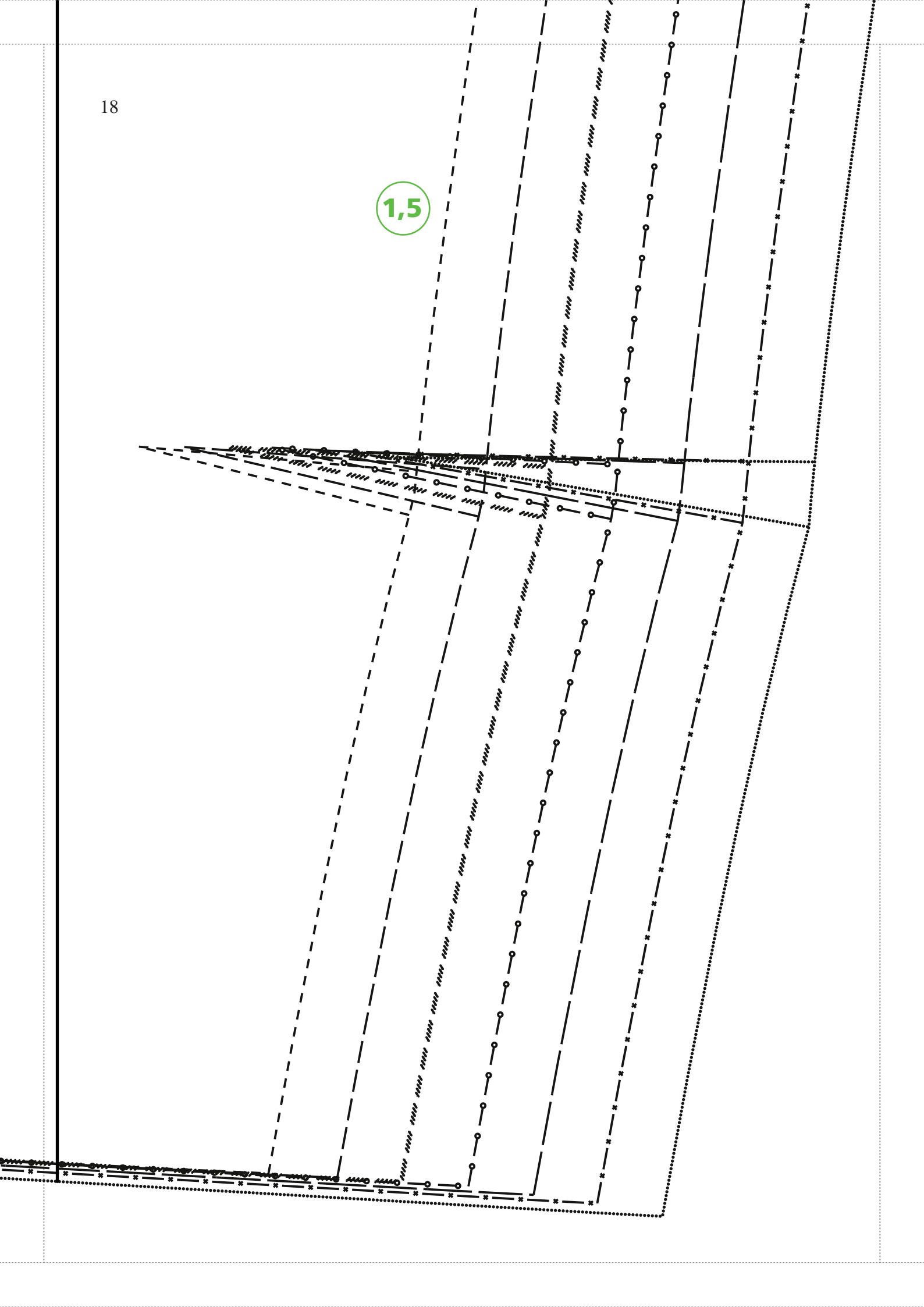

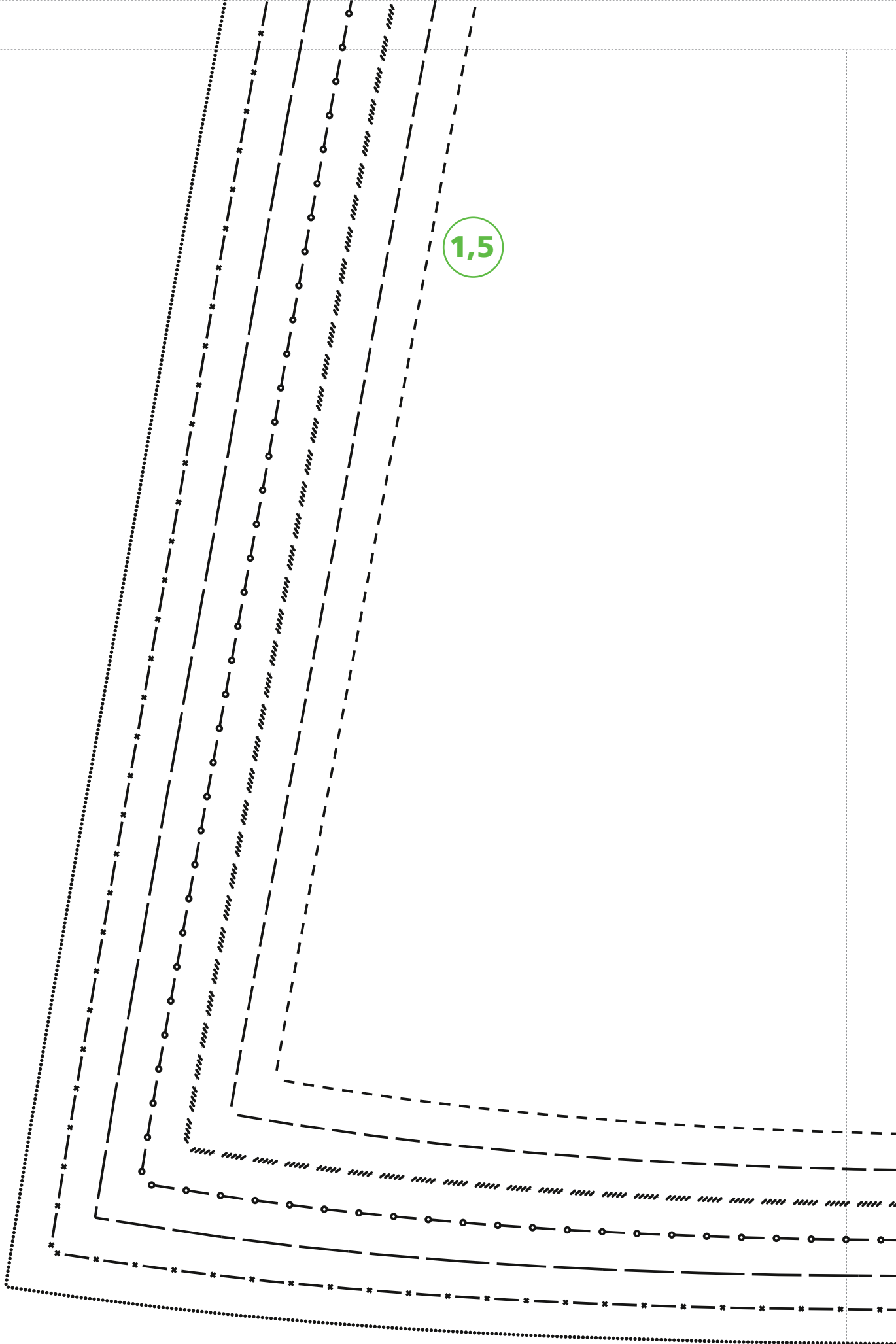

1,5

3,5

A series of horizontal lines for handwriting practice. From top to bottom: a dashed line, a solid line, a line with diagonal hatching, a line with small circles, a solid line, a line with asterisks, and a dotted line.