

Sweatshirt

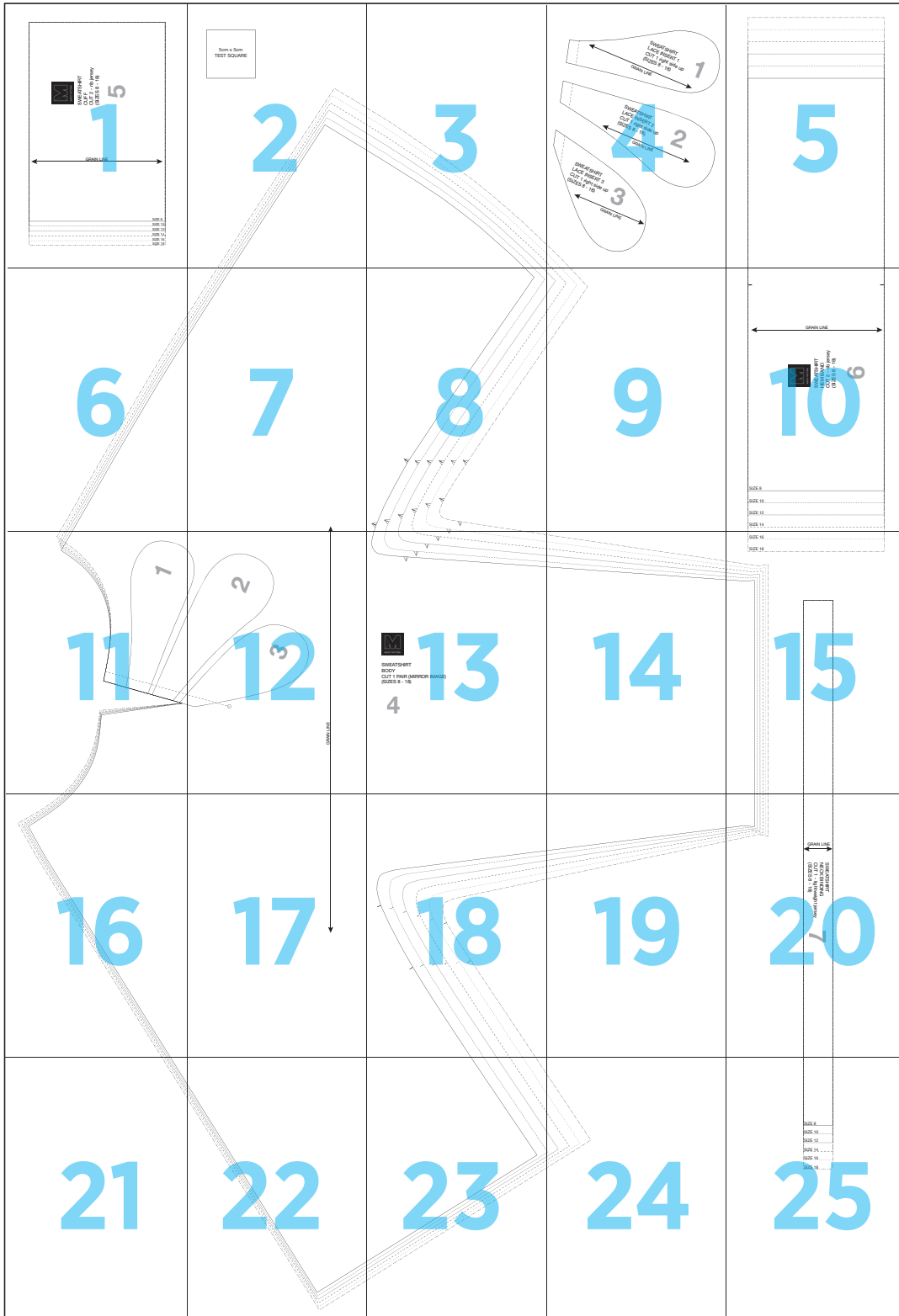

1



SWEATSHIRT
CUFF
CUT 2 - rib jersey
(SIZES 8 - 18)

5



Solid line	SIZE 8
Dashed line	SIZE 10
Wavy line	SIZE 12
Dashed line	SIZE 14
Dotted line	SIZE 16
Dotted line	SIZE 18



2

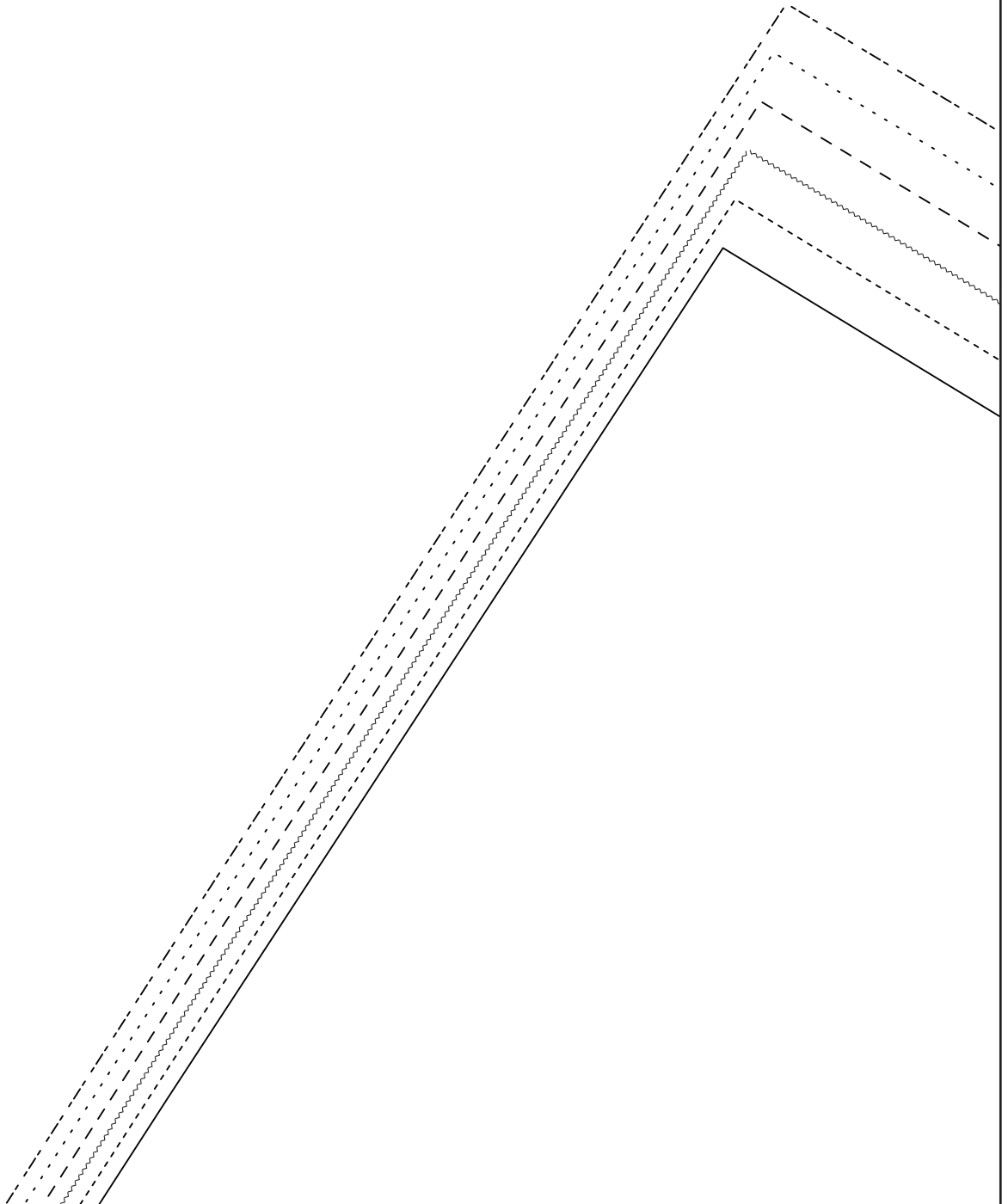
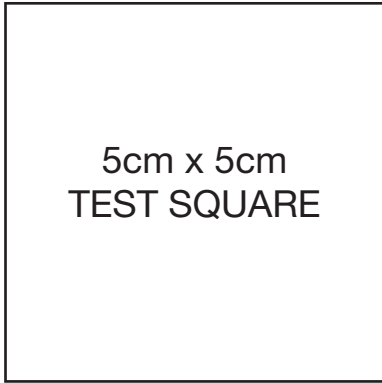

3

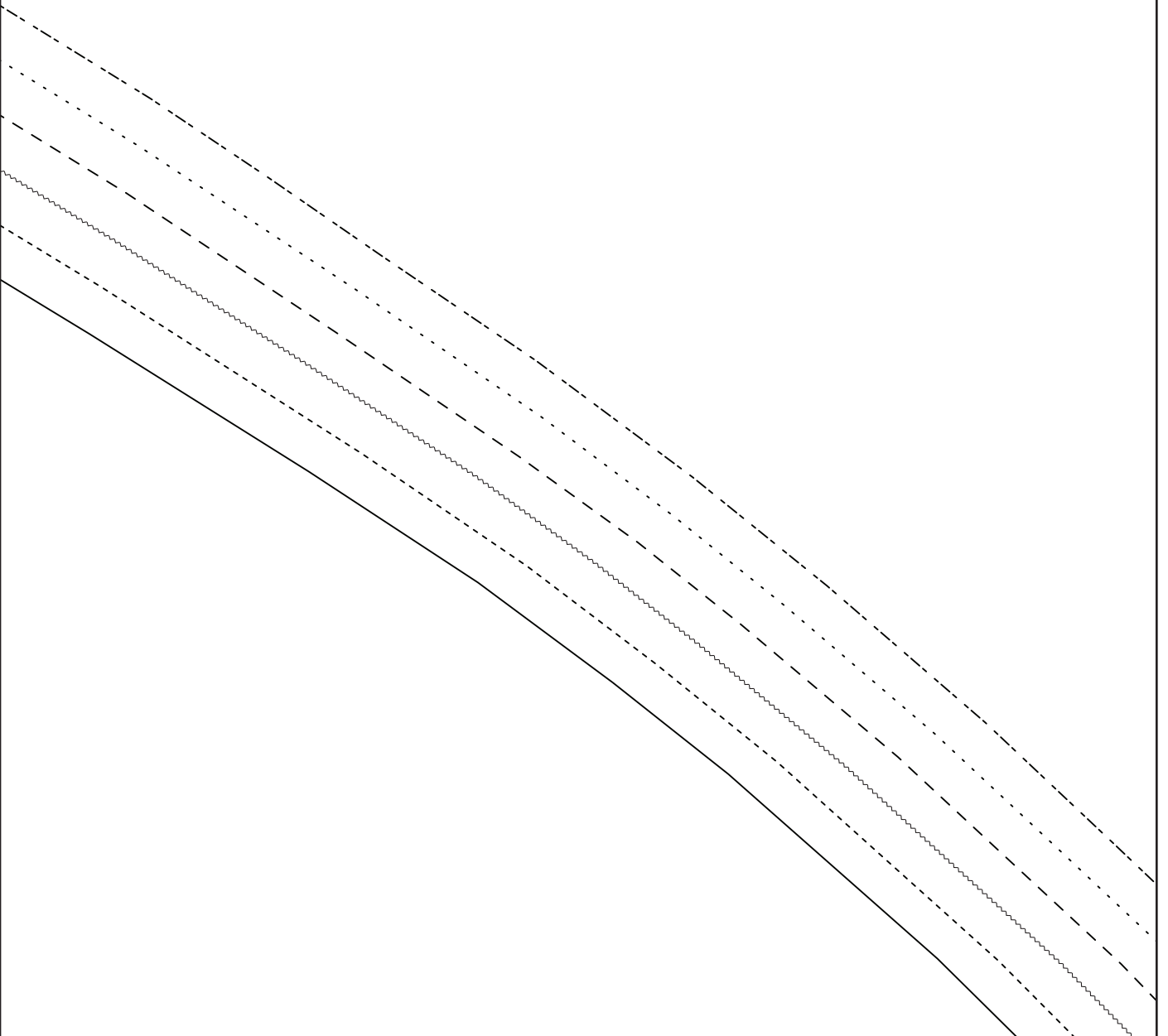

4

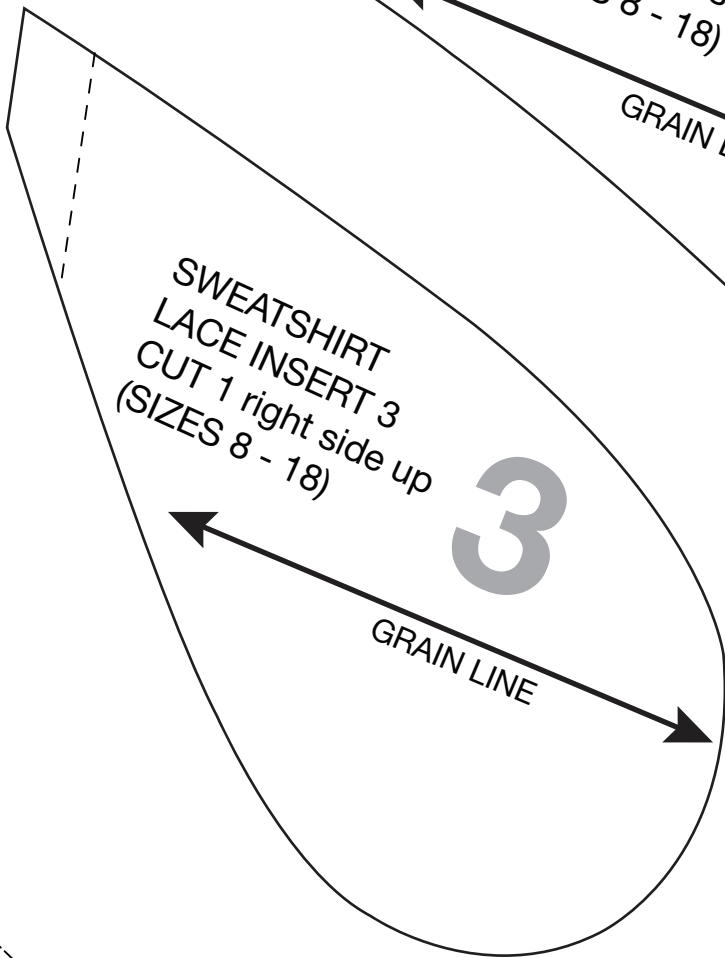
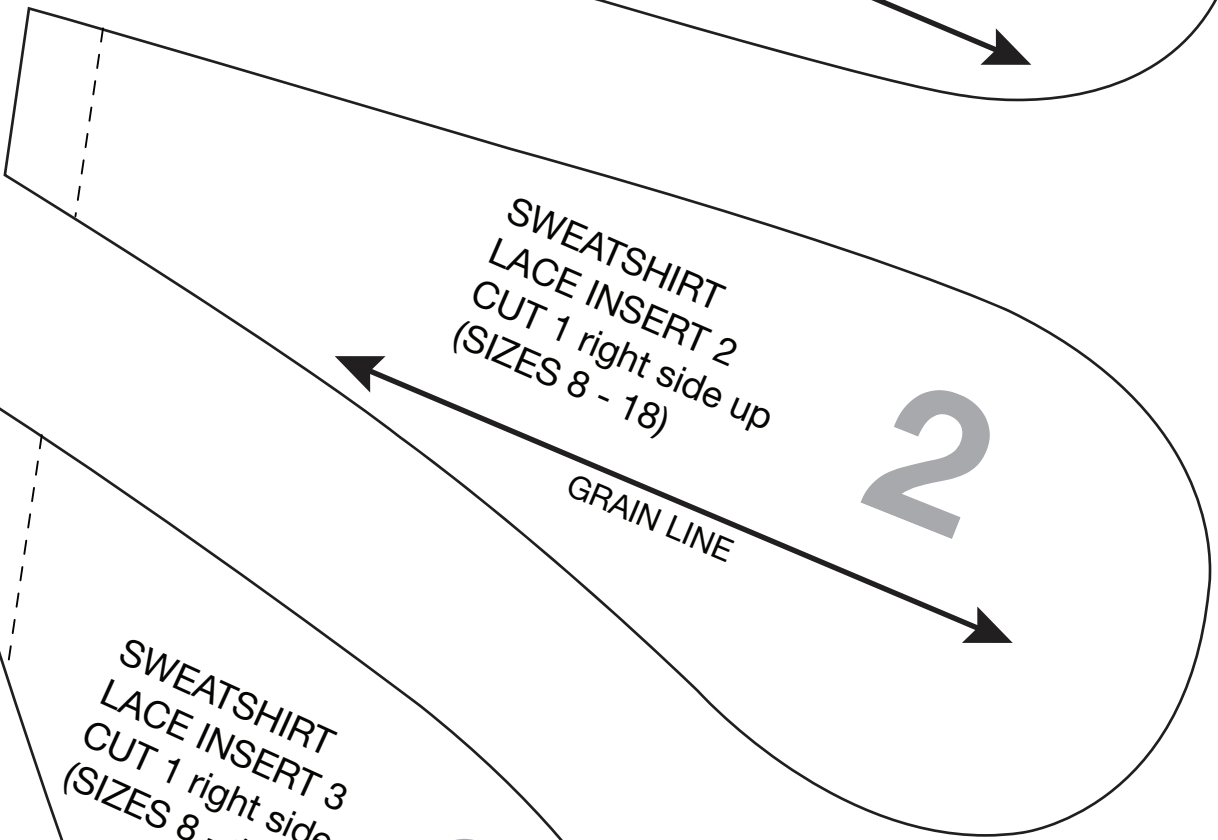
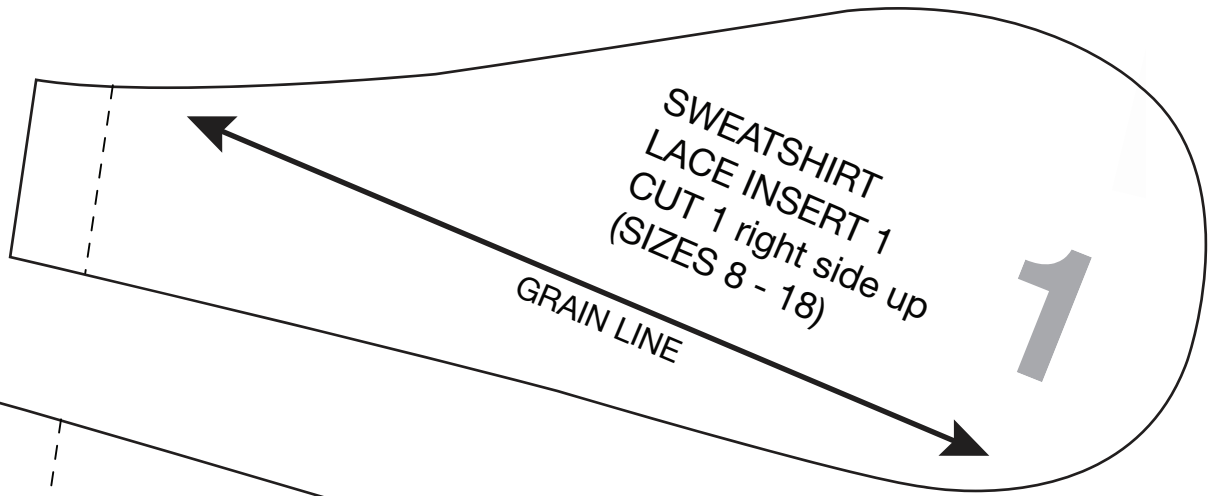

5

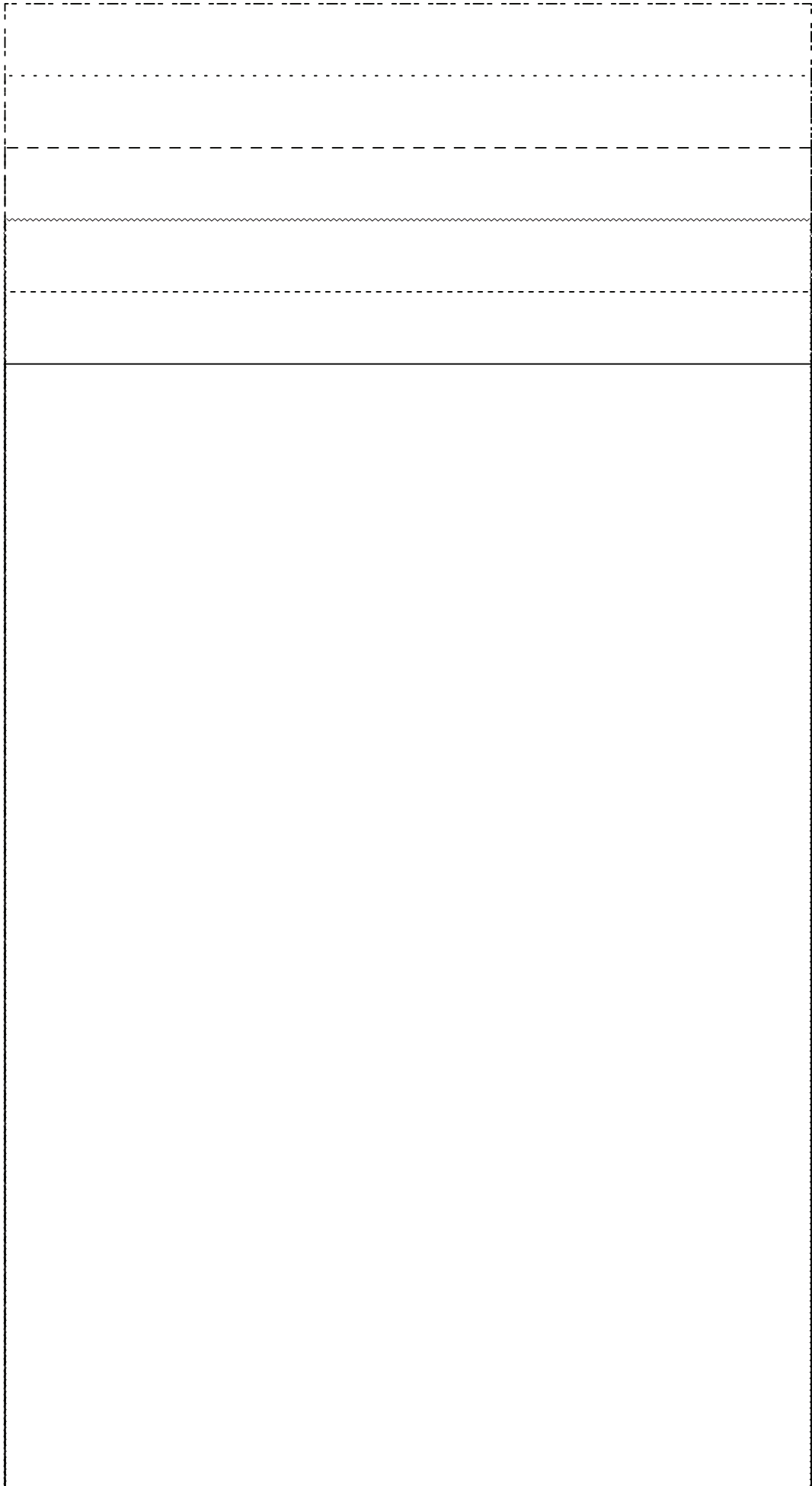

6

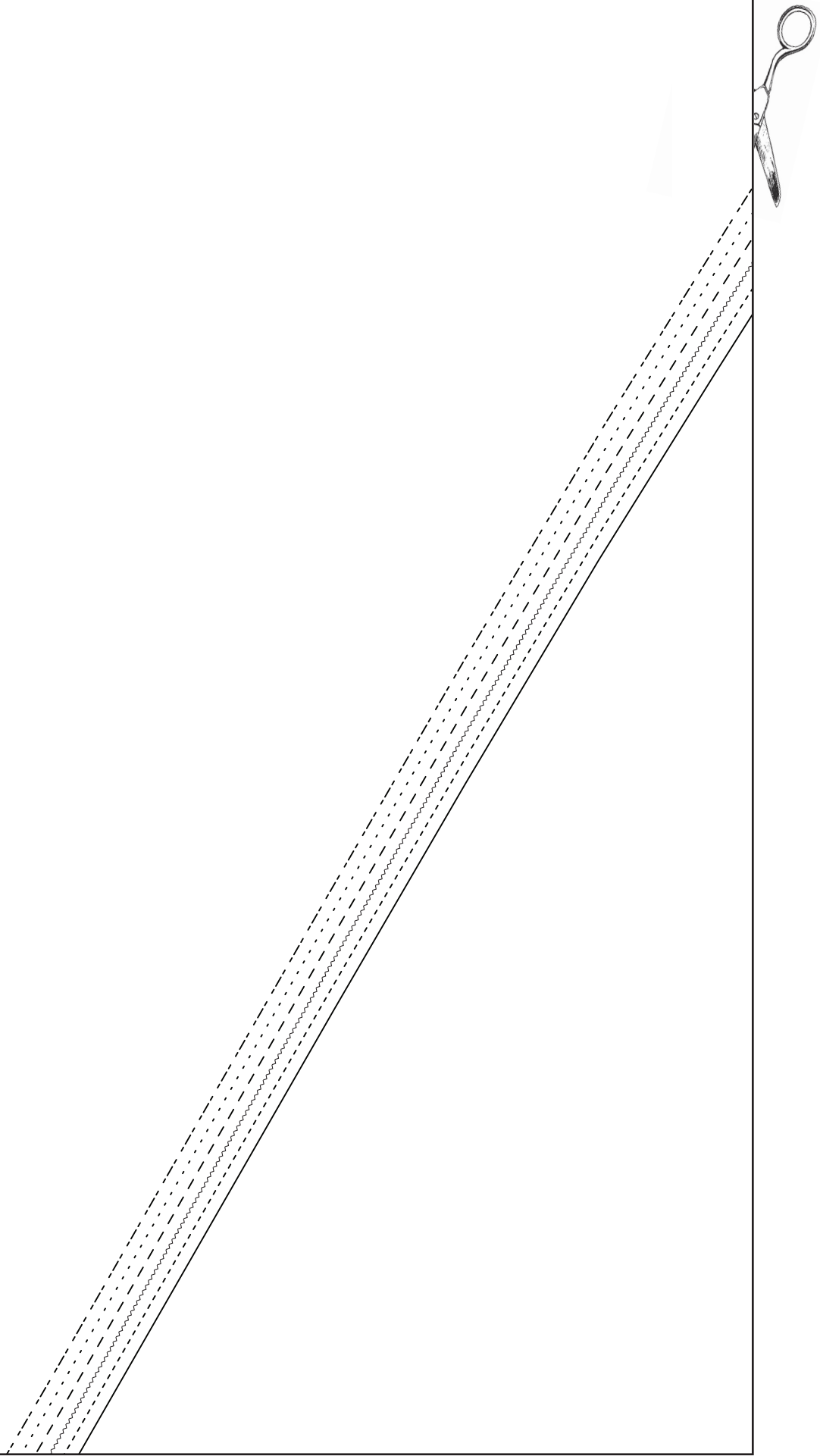

7

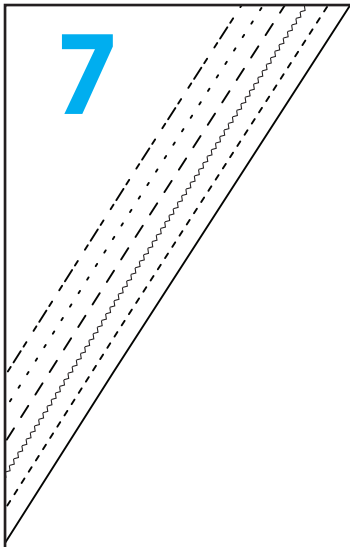

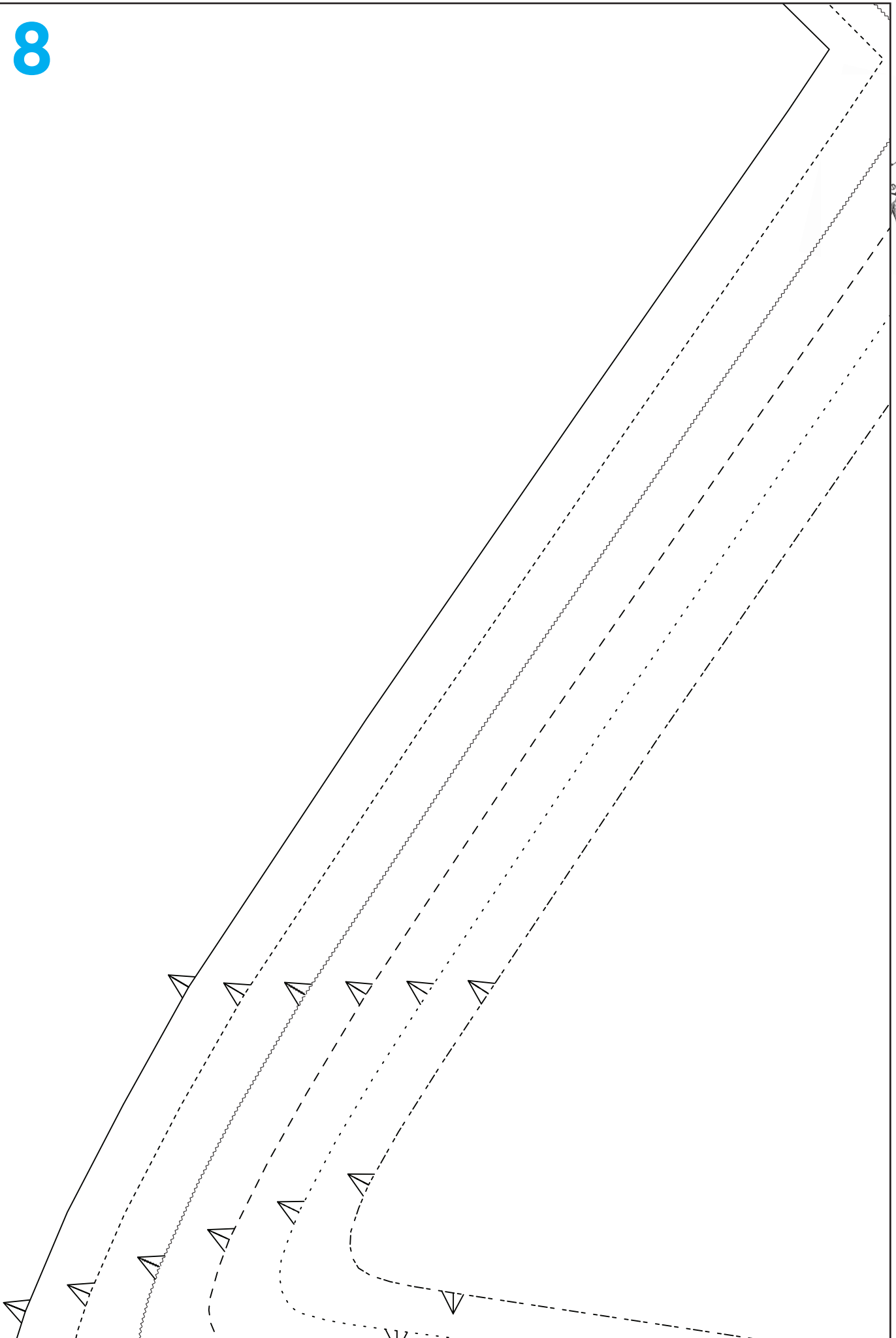

9

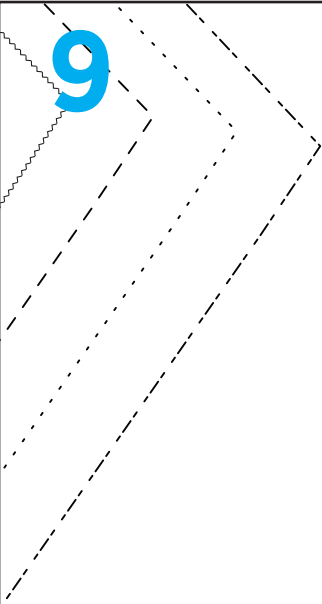

10

GRAIN LINE



SWEATSHIRT
HEM BAND
CUT 2 - rib jersey
(SIZES 8 - 18)

6



SIZE 8

SIZE 10

SIZE 12

SIZE 14

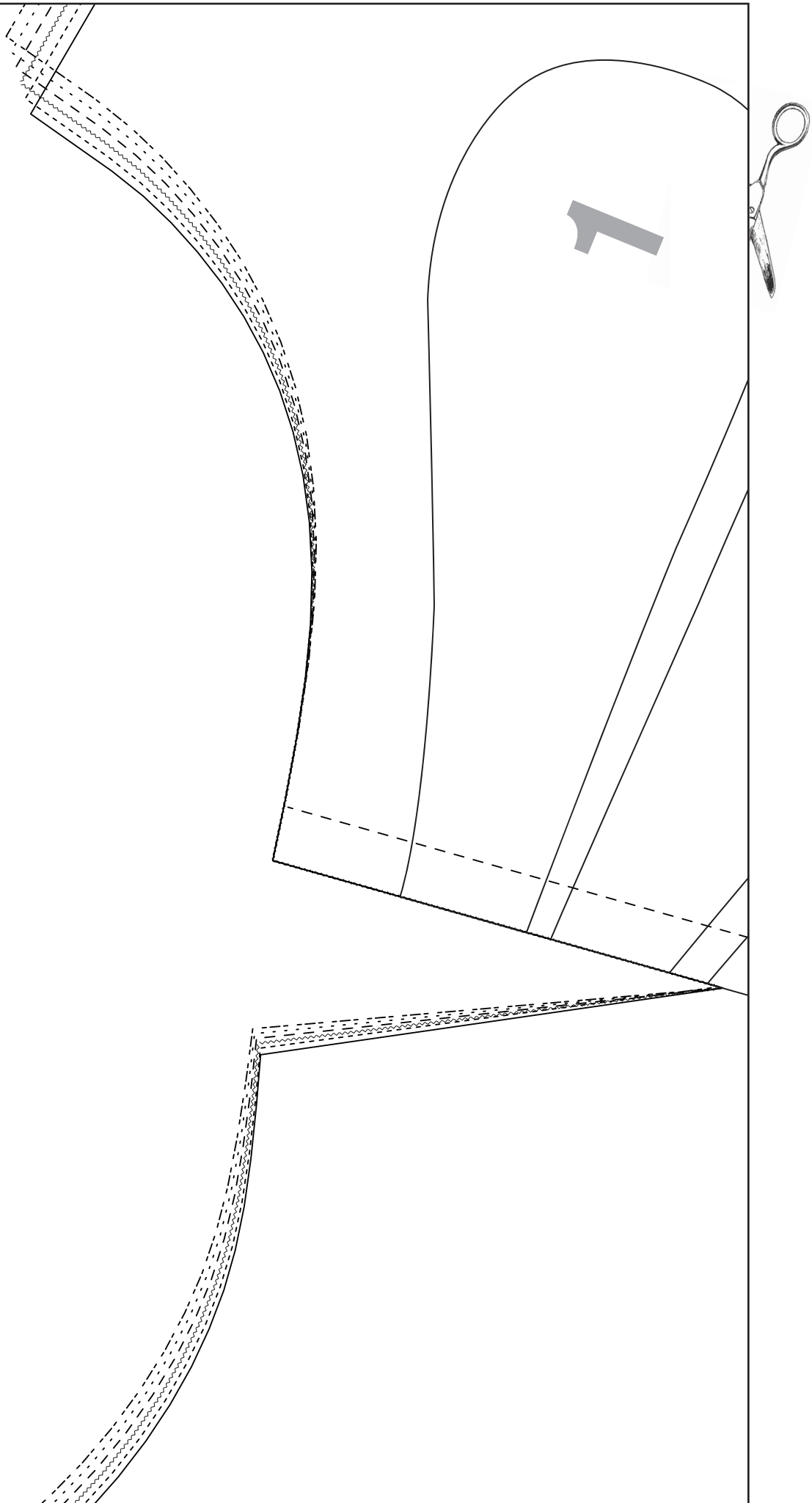

12

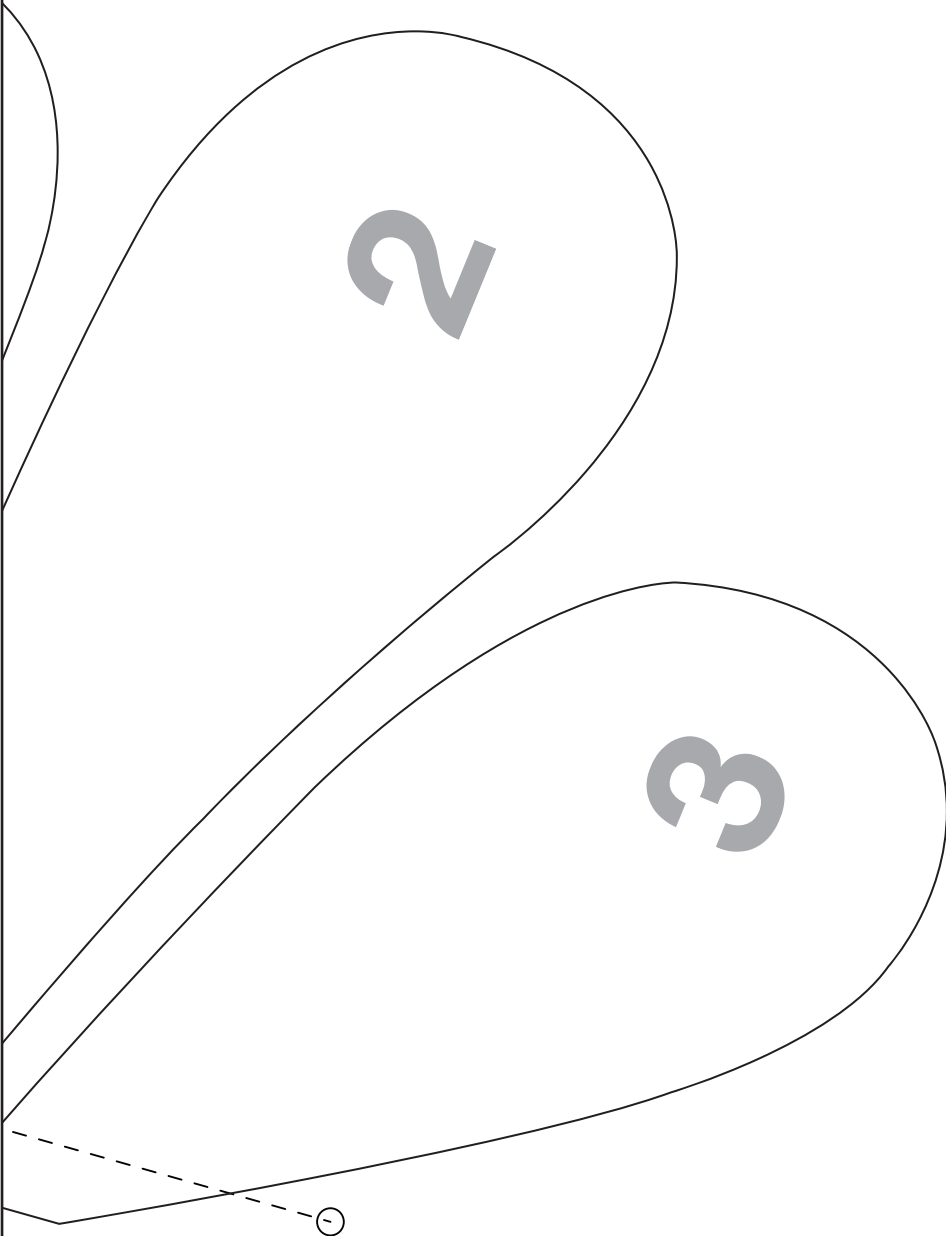

GRAIN LINE



13

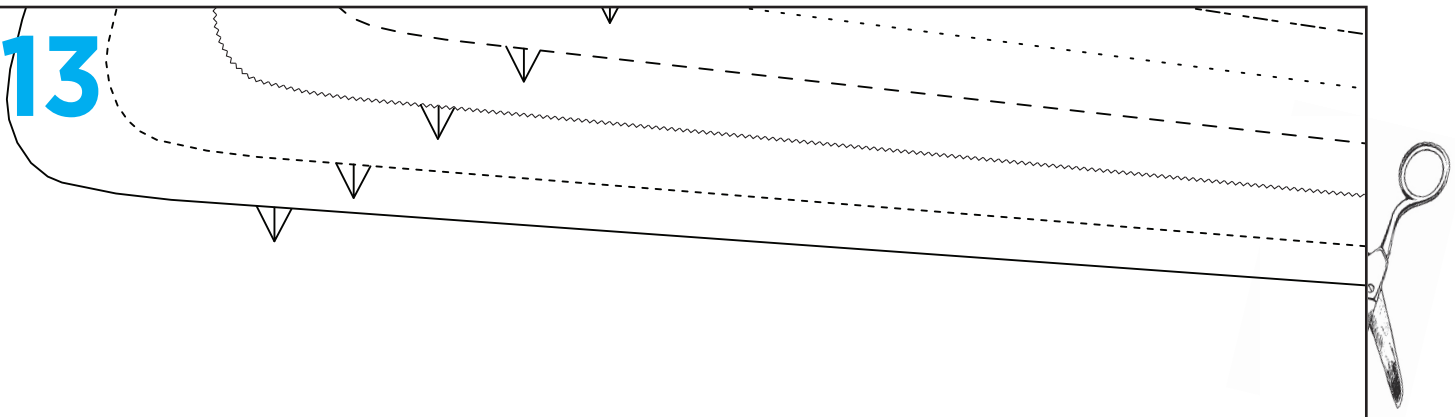

SWEATSHIRT
BODY
CUT 1 PAIR (MIRROR IMAGE)
(SIZES 8 - 18)

4

14



15

SIZE 16

SIZE 18

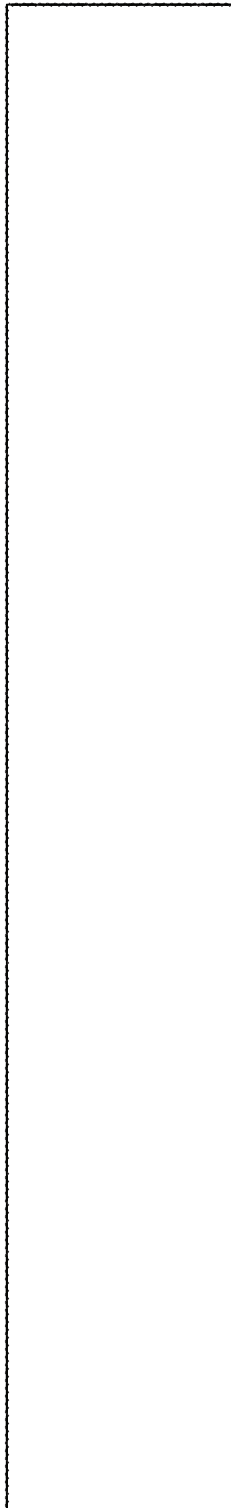
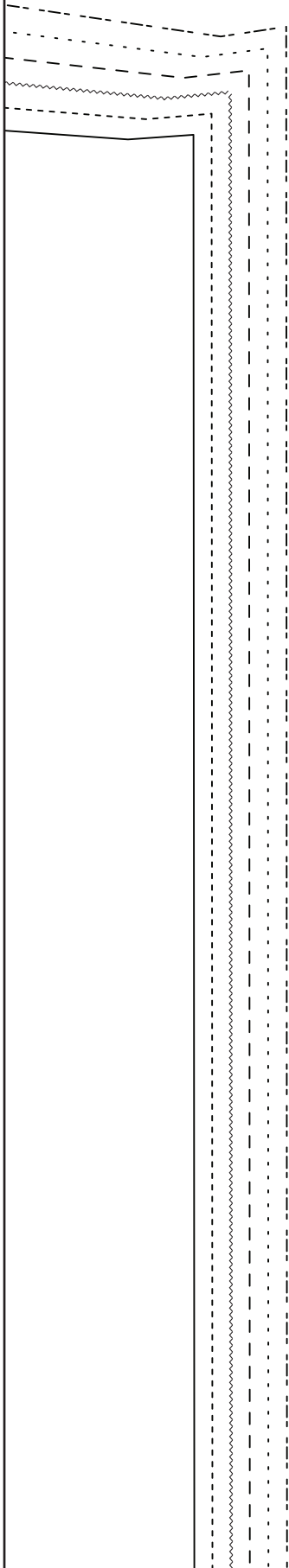

16

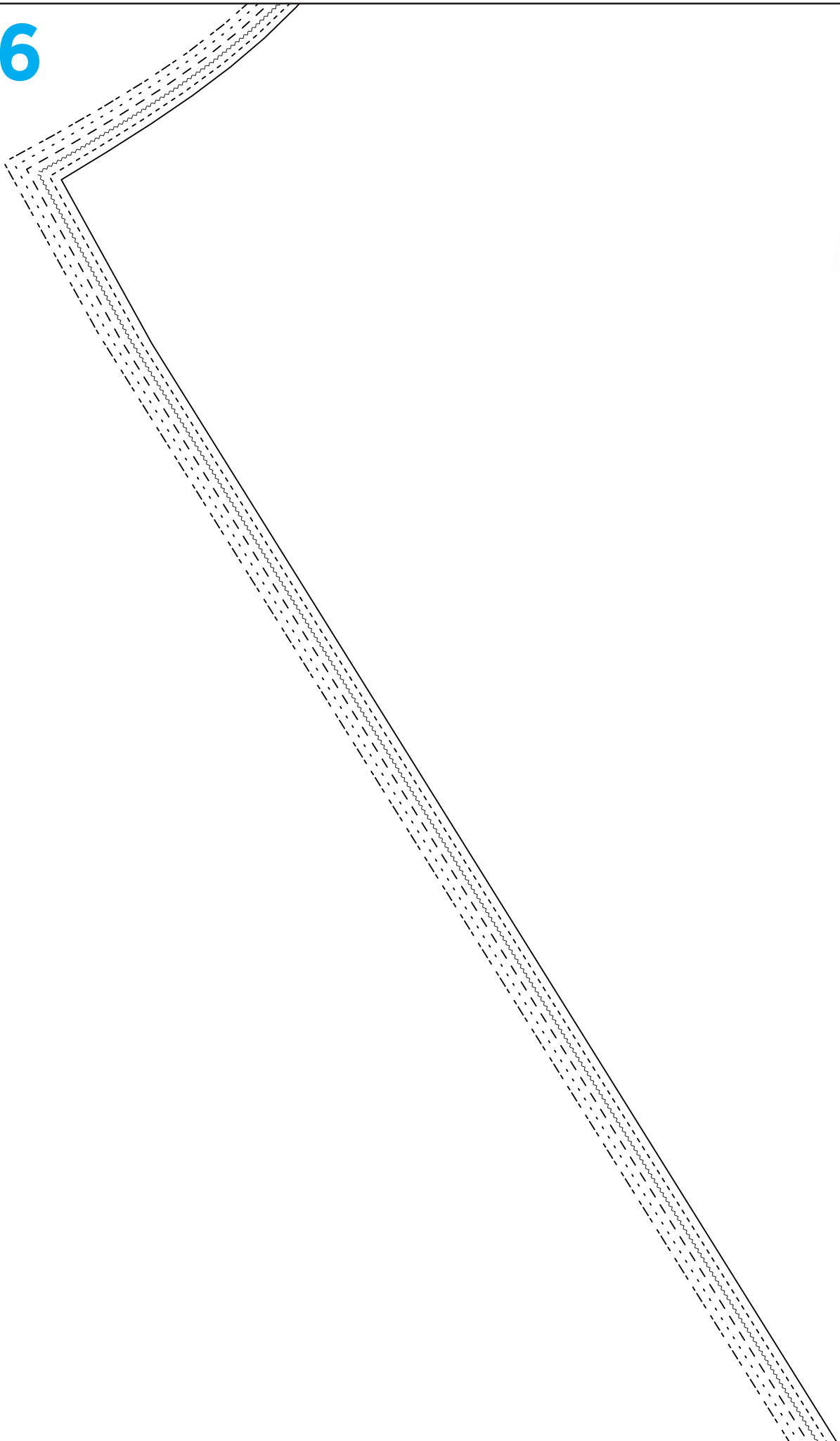

17



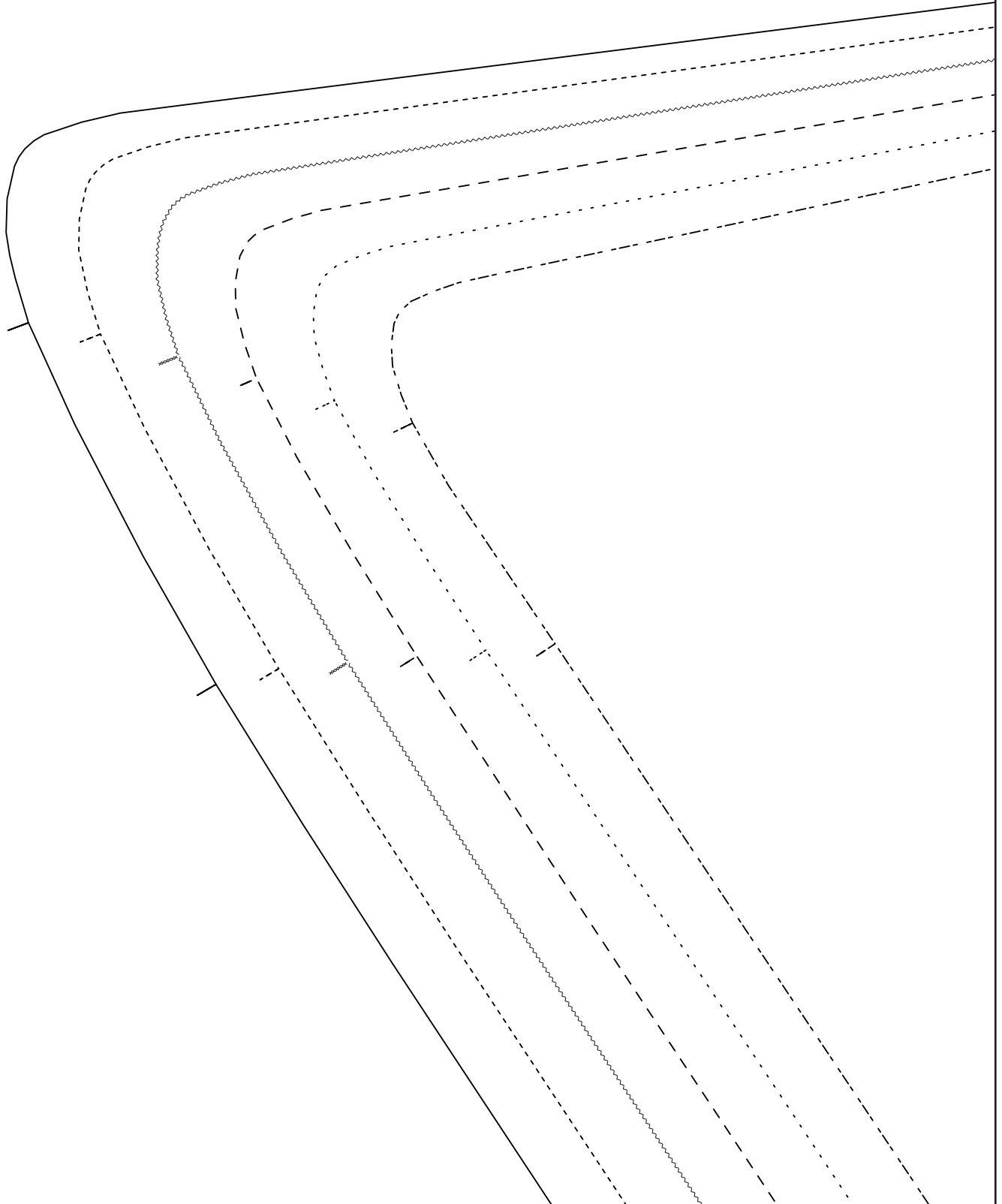

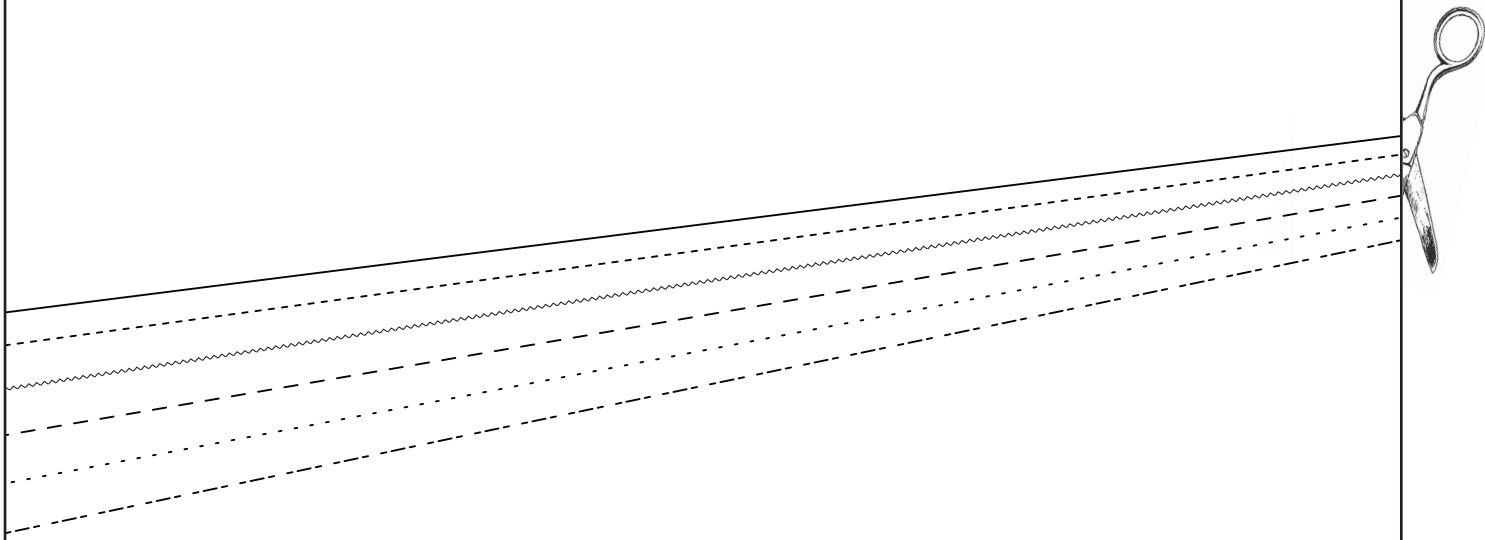

20

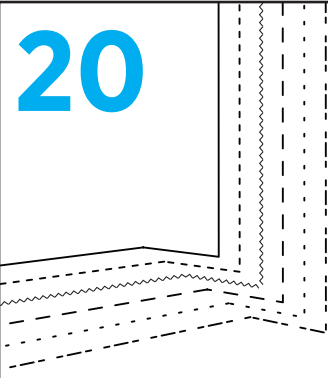

GRAIN LINE



SWEATSHIRT
NECK BINDING
CUT 1 - lightweight jersey
(SIZES 8 - 18)



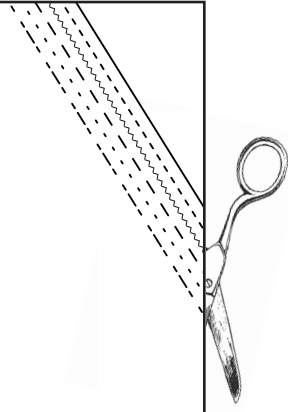

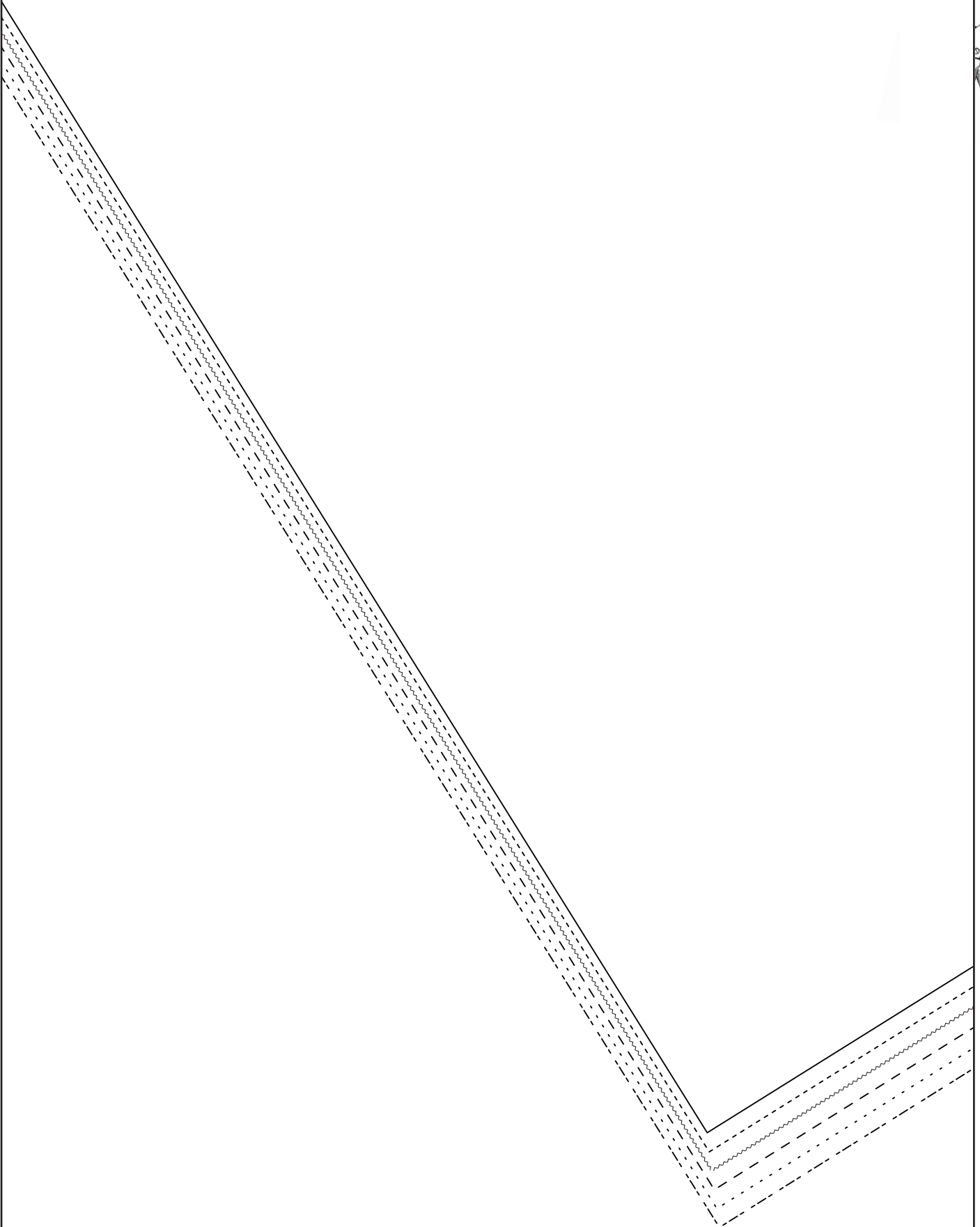

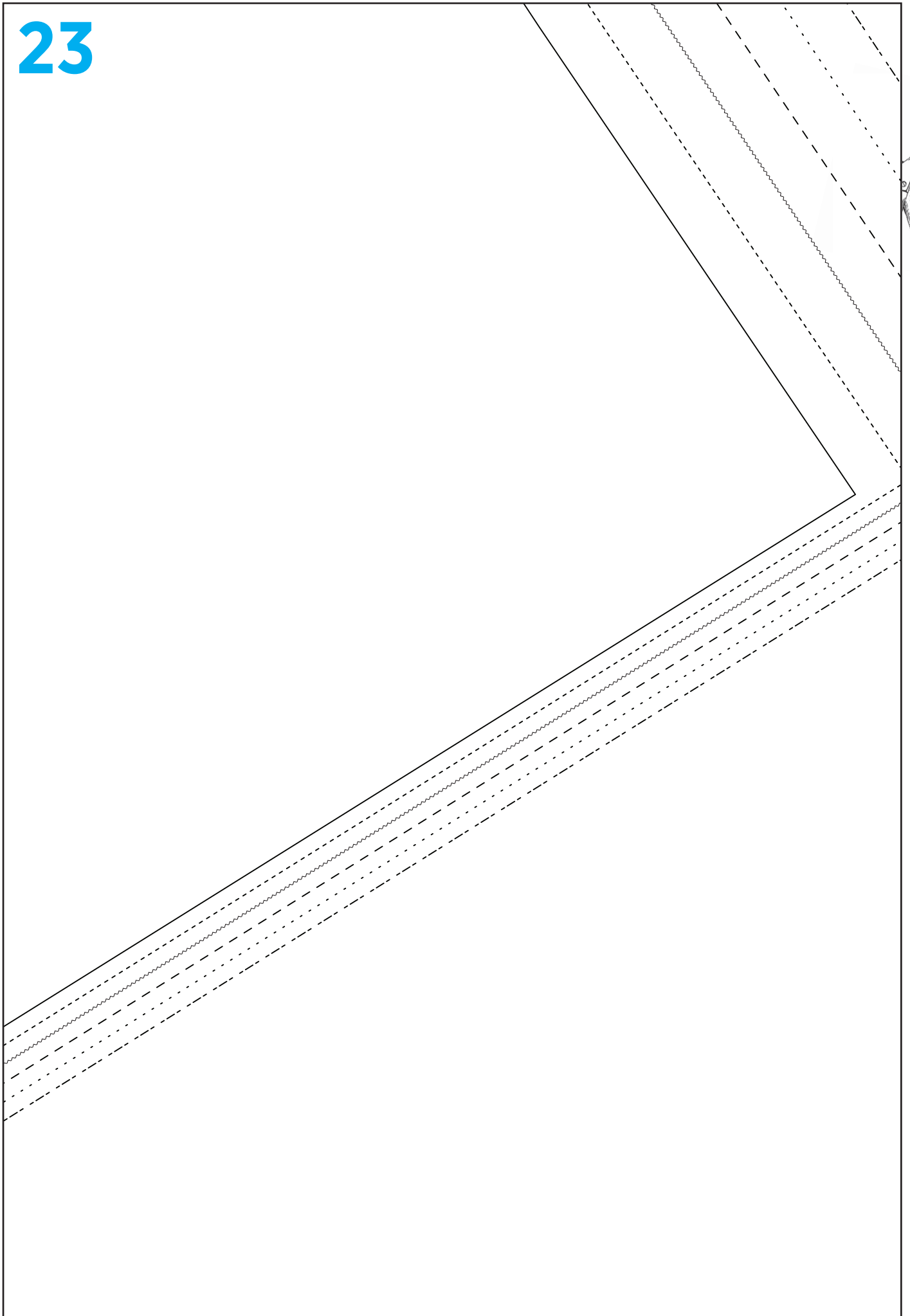

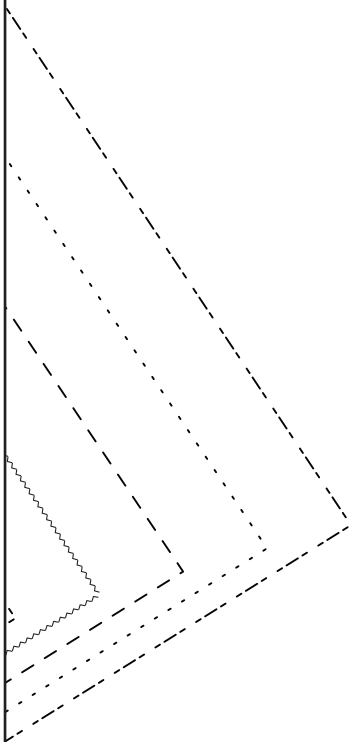

25

SIZE 8

SIZE 10

SIZE 12

SIZE 14

SIZE 16

SIZE 18

