

Issue 95 March issue 2017

MOTIFS & TEMPLATES

PRINT
OUT
& KEEP

Use these guides to get started today

FIND THE TEMPLATE YOU REQUIRE ON THE CONTENTS LIST BELOW AND JUST PRINT OUT THE PAGE OR PAGES YOU NEED FROM YOUR PRINT MENU

In your print menu, under Size options, be sure to select to print 'Actual Size', instead of 'Fit to Page'

Page 2-18

Title: Poppy tank top
Designer: Theresa Gonzalez
(extracted from *Sunday Sews*,
£15.99, Chronicle Books,
www.abramsandchronicle.co.uk)
Magazine page: 18

Page 19-21

Title: No-pattern dressing gown
Designer: Amanda Walker
Magazine page: 34

Page 22

Title: Block of the Month
Designer: Corinne Bradd
Magazine page: 57

Page 23

Title: Susie's Stitch School
Designer: Susie Johns
Magazine page: 62

Page 24-27

Title: Rucksack course
Designer: Debbie Von Grabler-Crozier
Magazine page: 70

Page 28-29

Title: Retro style apron
Designer: Ellen Kharade
Magazine page: 74

Page 30

Title: Fairytale hoop
Designer: Susie Johns
Magazine page: 77

Page 31-33

Title: Rag dolly Violet
Designer: Ruth Oliver
Magazine page: 82

Page 34-51

Title: Mermaid tail
Designer: Carolyn Letten
Magazine page: 84

Title: Poppy tank top

Designer: Theresa Gonzalez (extracted from *Sunday Sew*, £15.99, Chronicle Books, www.abramsandchronicle.co.uk)

Magazine page: 38

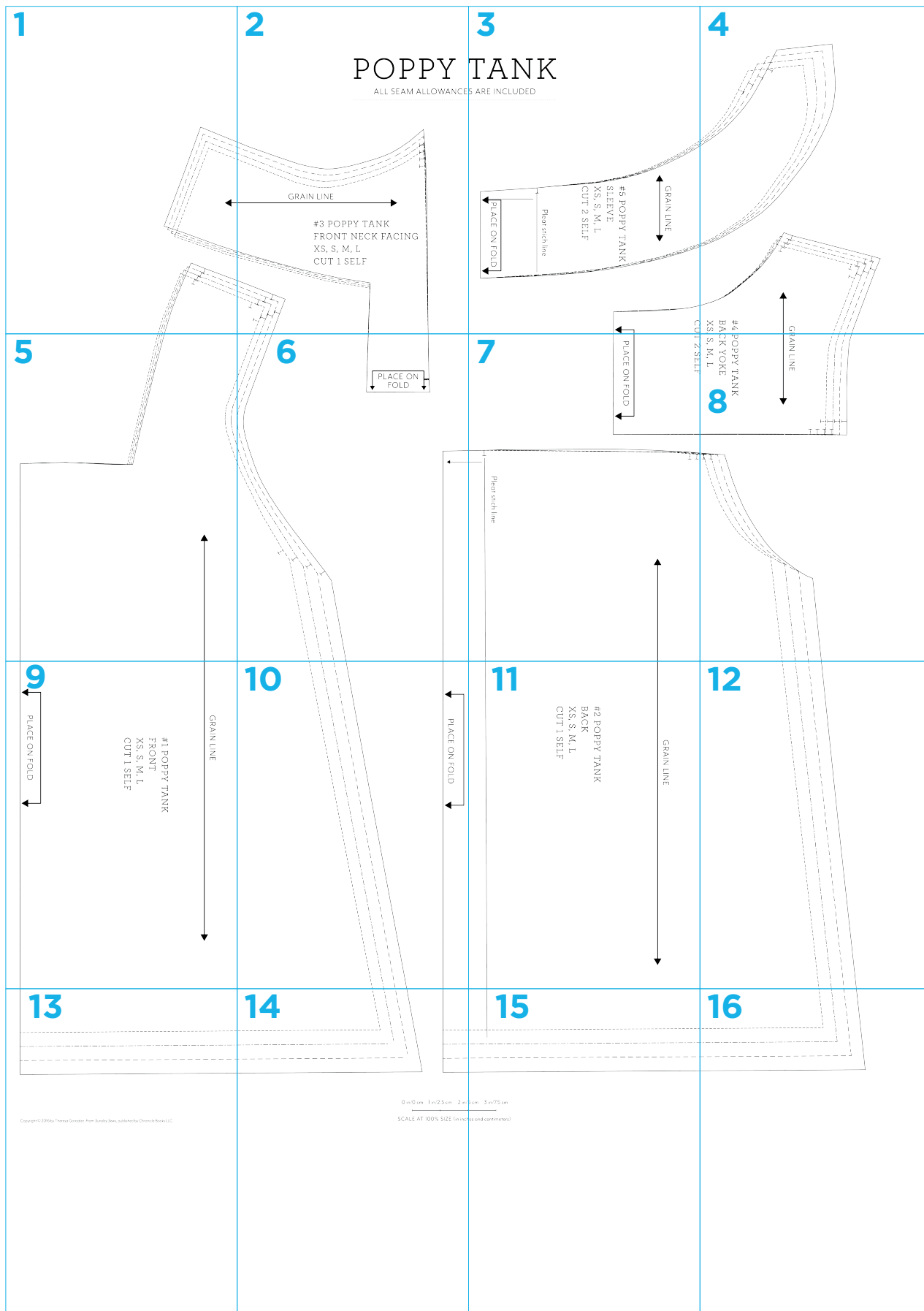

1

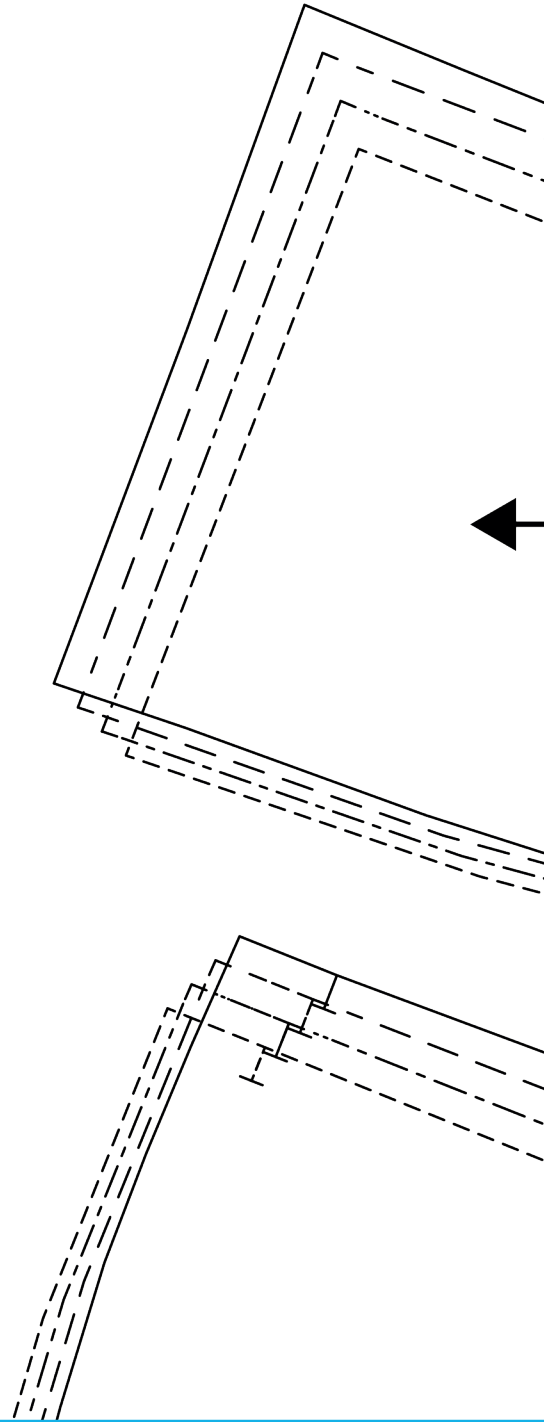

2

POPPY

ALL SEAM ALLOWANCE

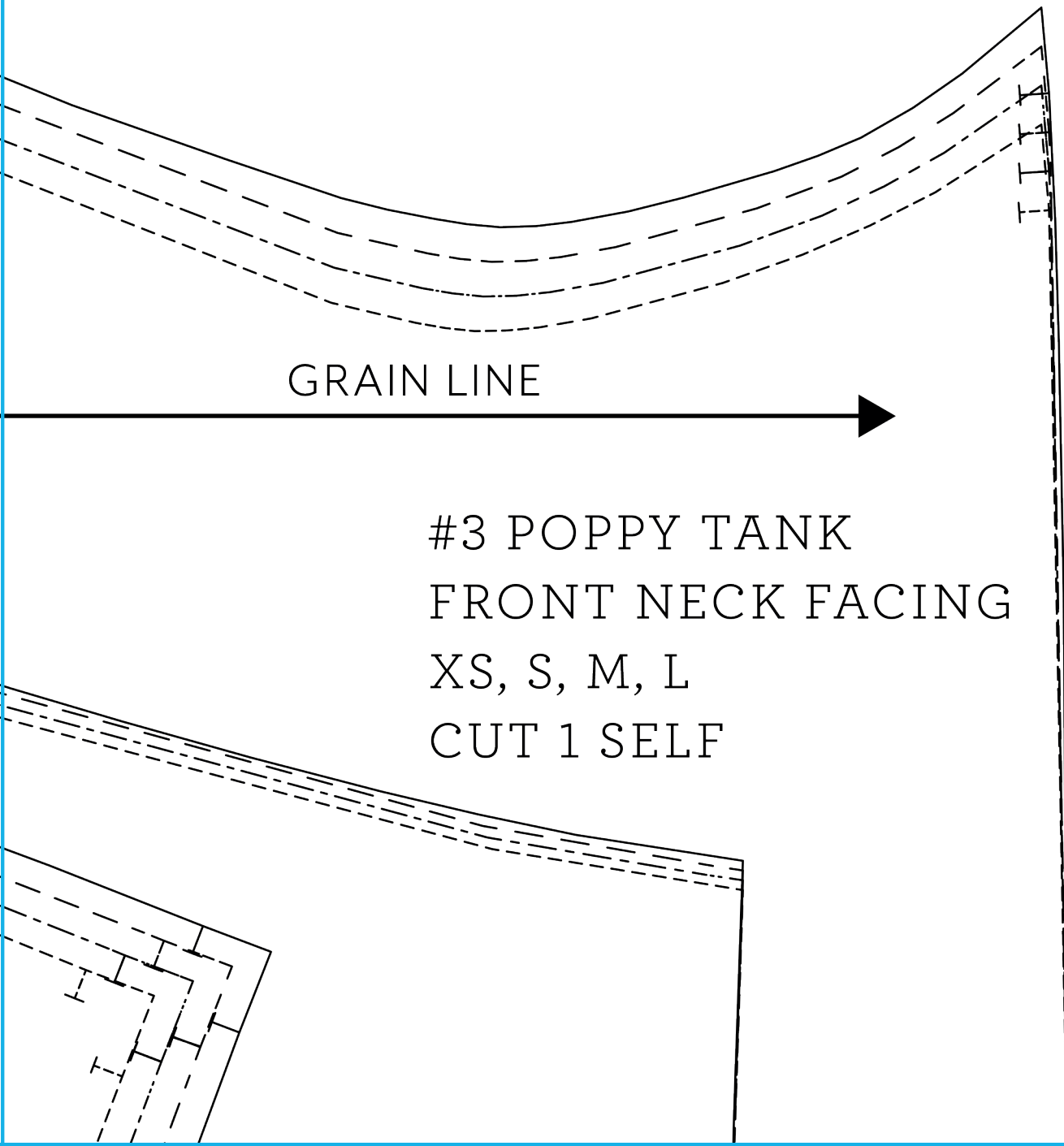

GRAIN LINE

#3 POPPY TANK
FRONT NECK FACING
XS, S, M, L
CUT 1 SELF

3

TANK

S ARE INCLUDED

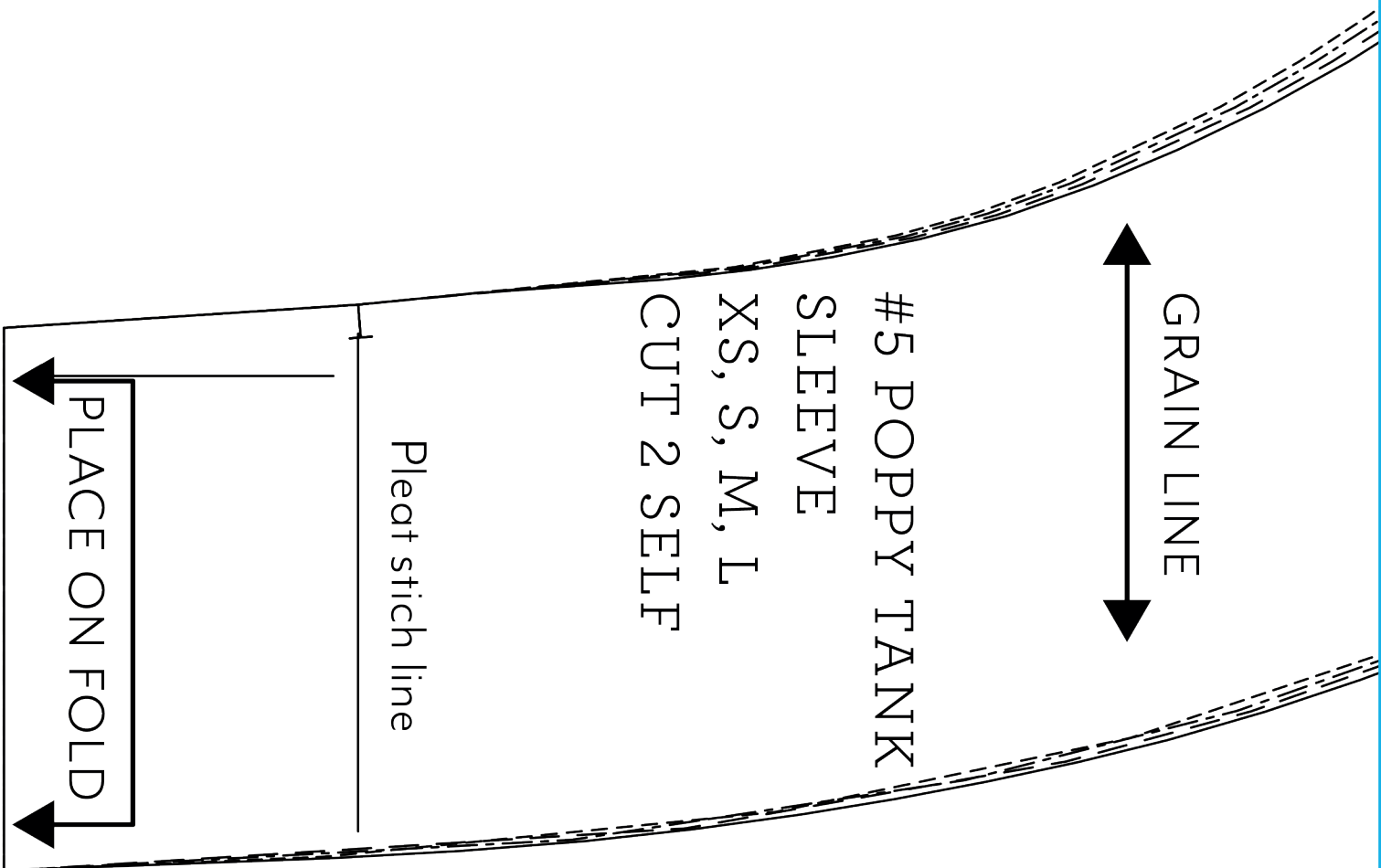

4

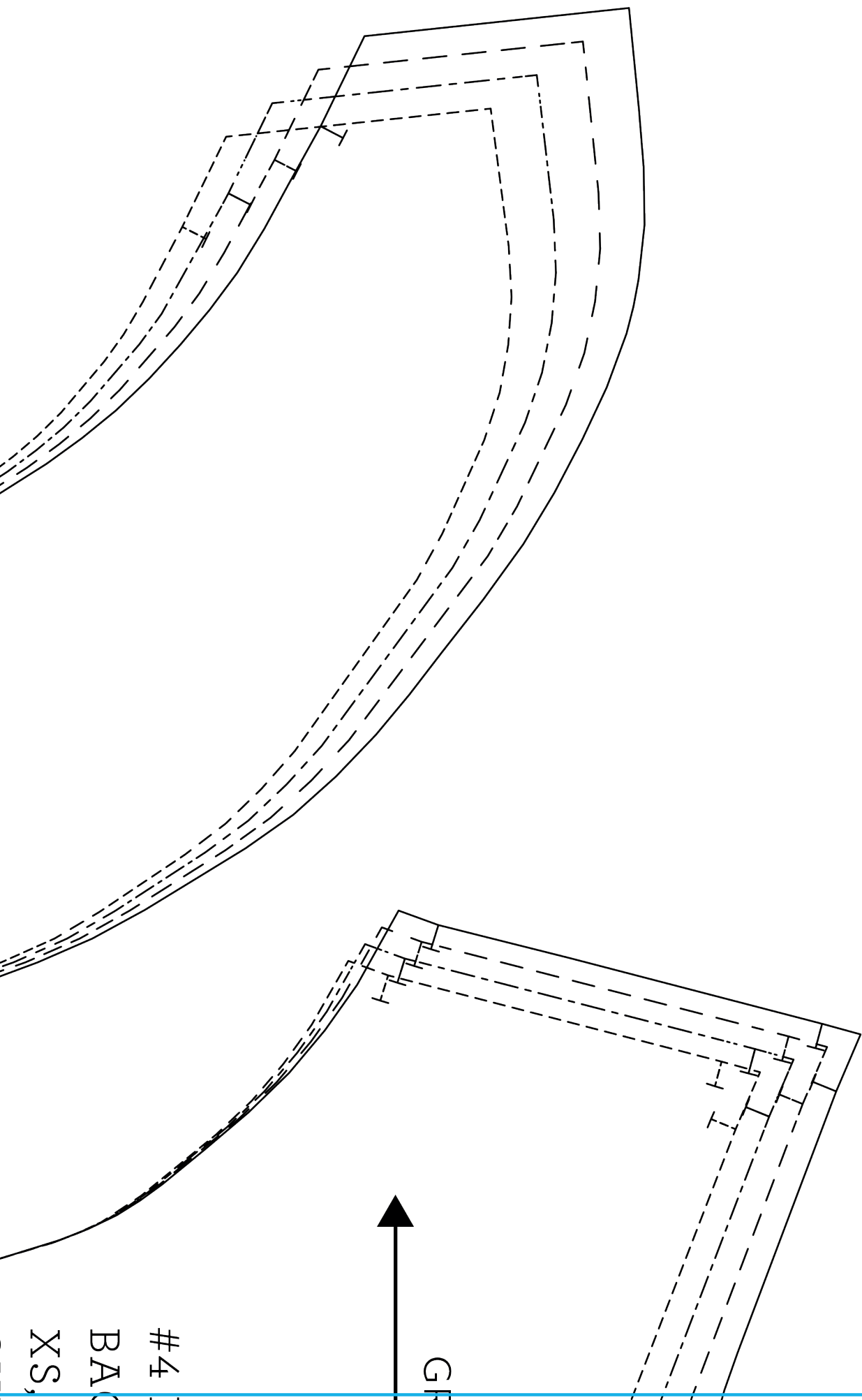

5

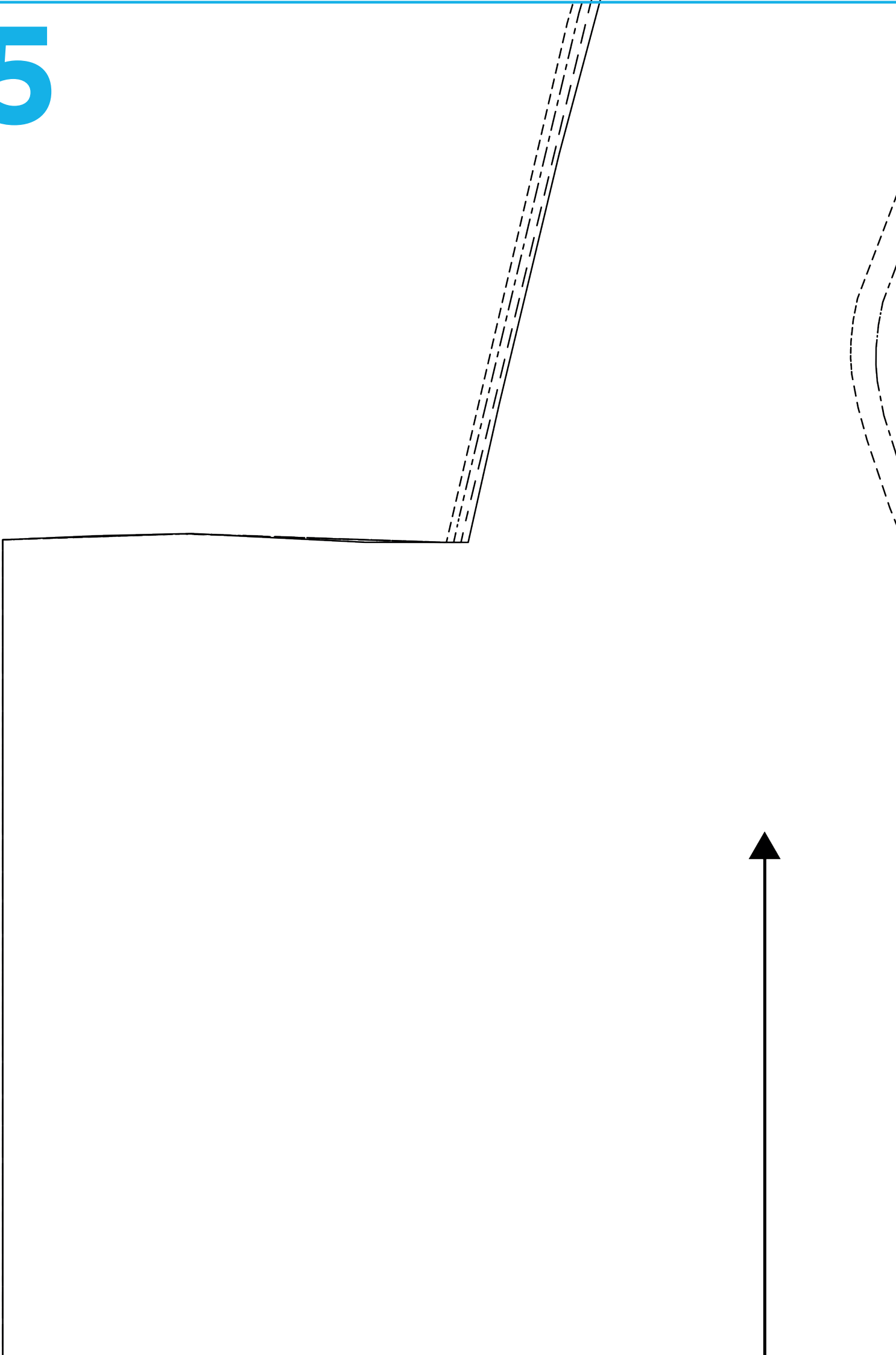

6

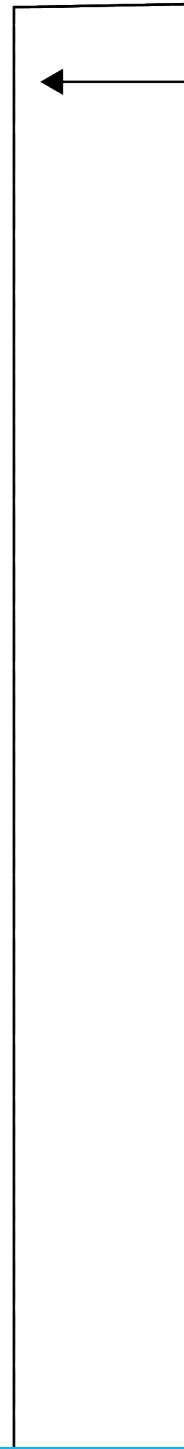
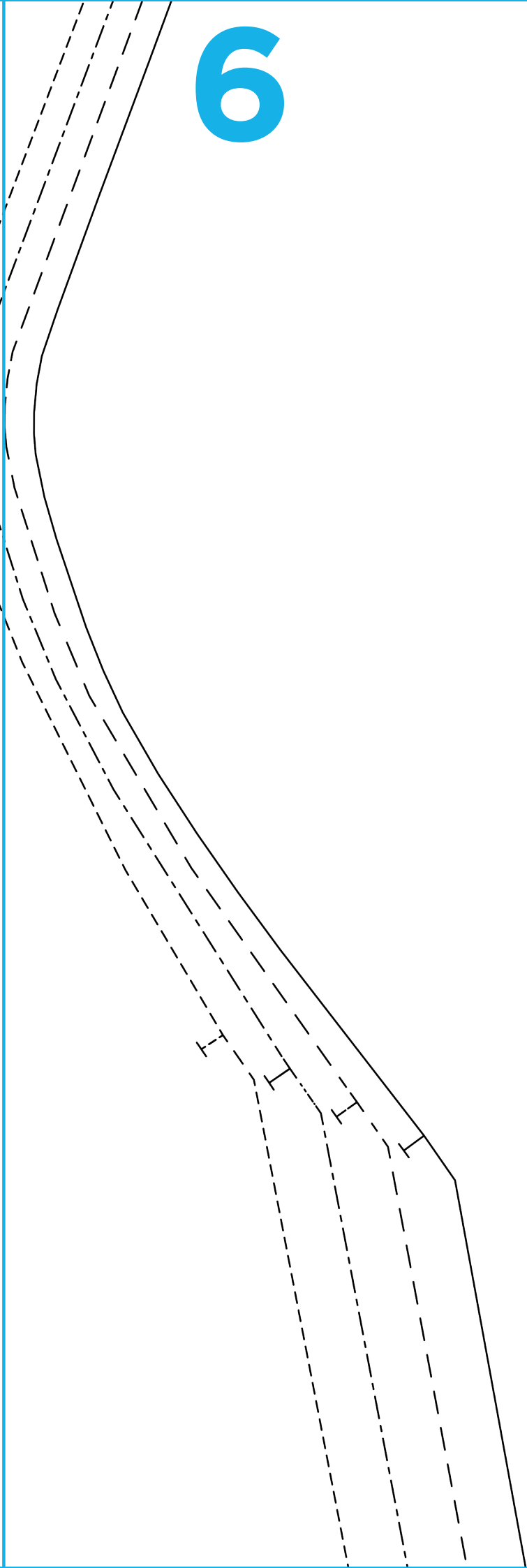
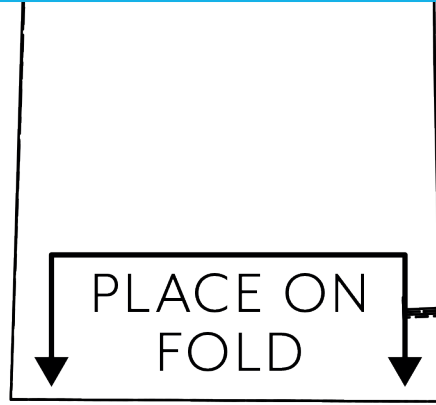

PLACE ON FOLD

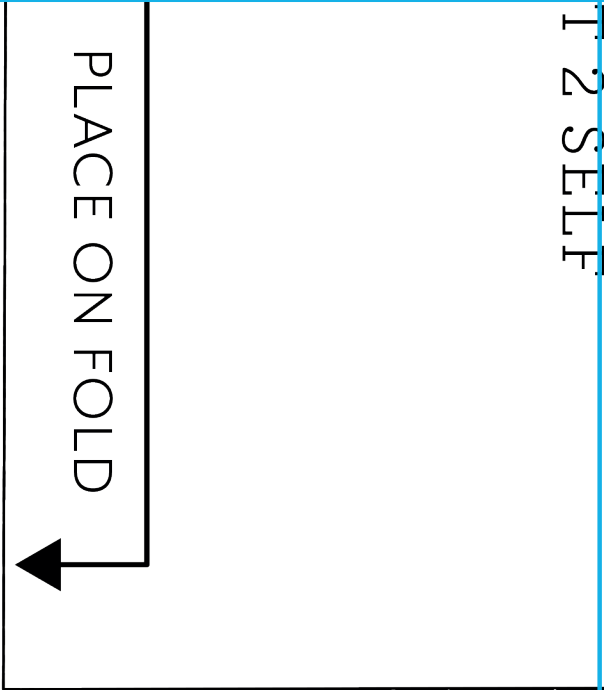

I I



Pleat stich line



RAIN LINE

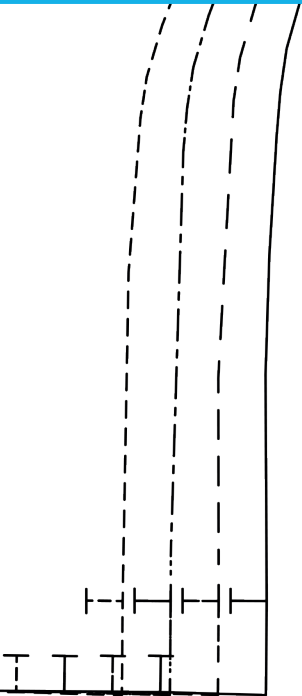

POPPY TANK

CK YOKE

S, M, L

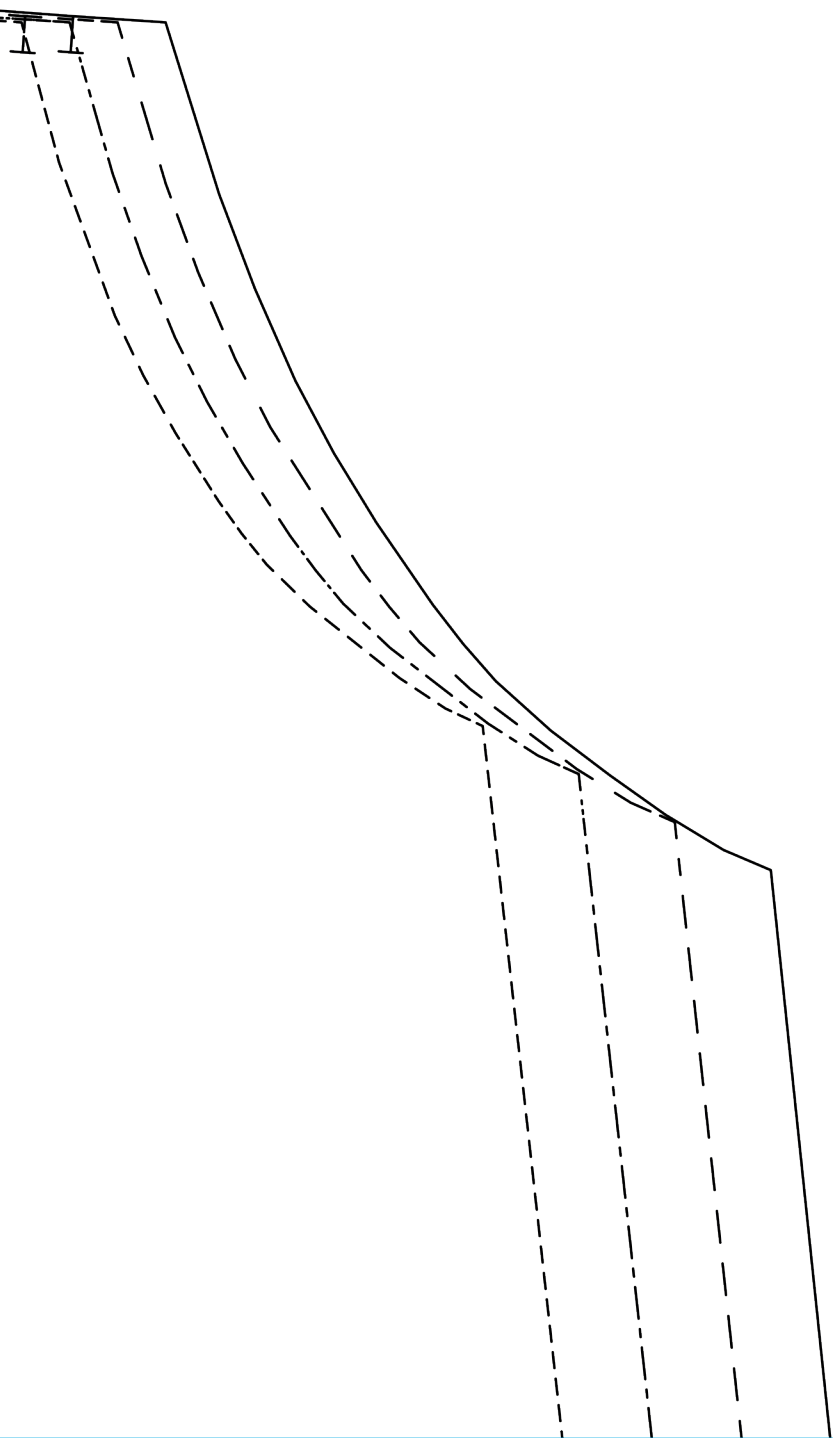

GRAIN LINE



#1 POPPY TANK
FRONT
XS, S, M, L
CUT 1 SELF

PLACE ON FOLD



6

10

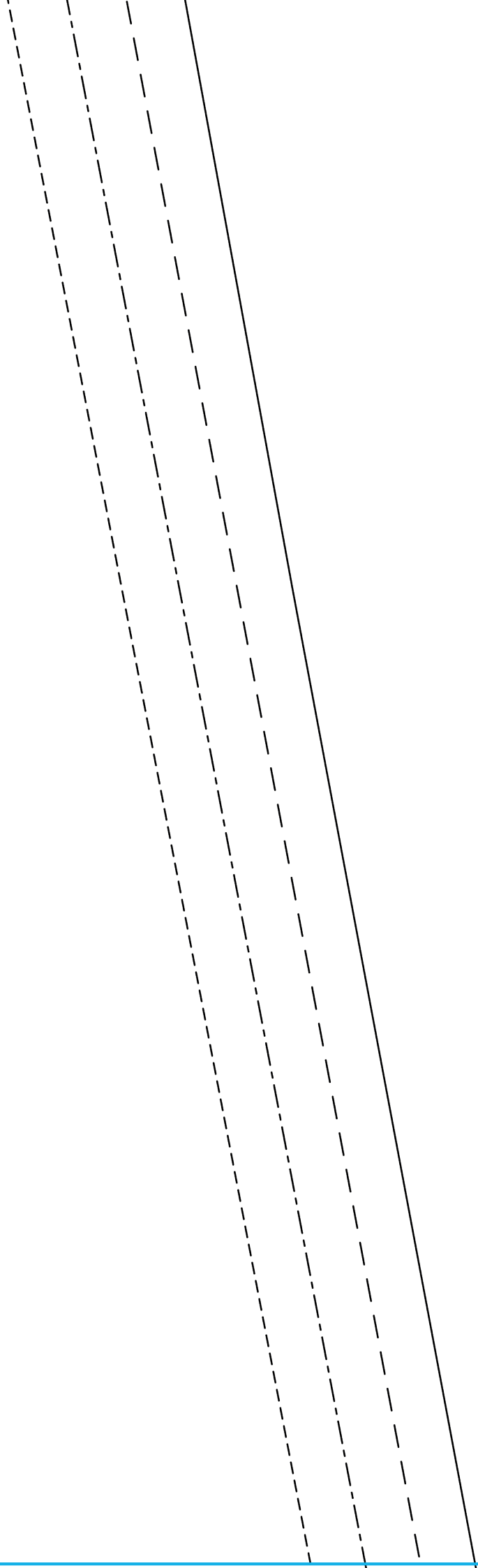

PLACE ON FOLD



GRAIN LINE



#2 POPPY TANK

BACK

XS, S, M, L

CUT 1 SELF

11

12

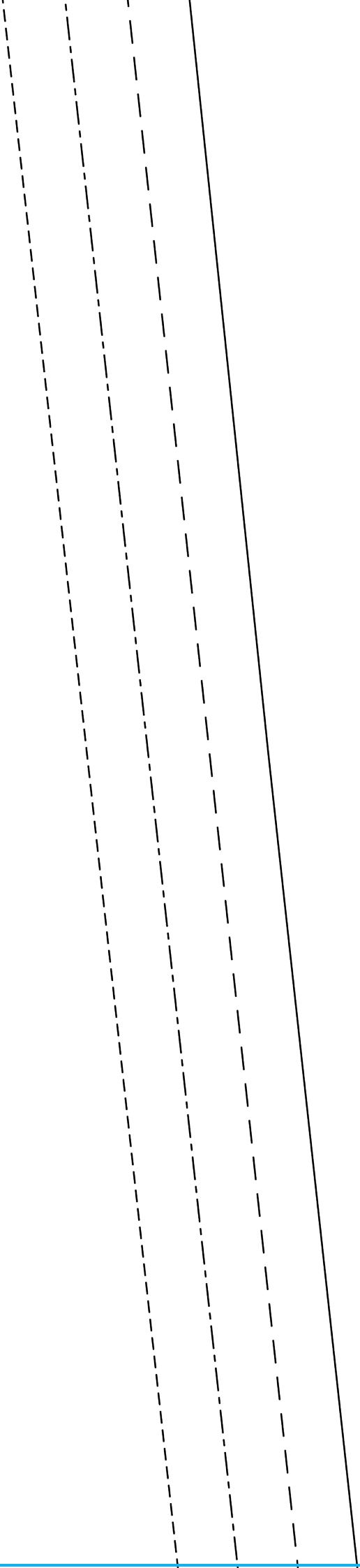

13

Copyright © 2016 by Theresa Gonzalez. From *Sunday Sews*, published by Chronicle Books LLC.

14

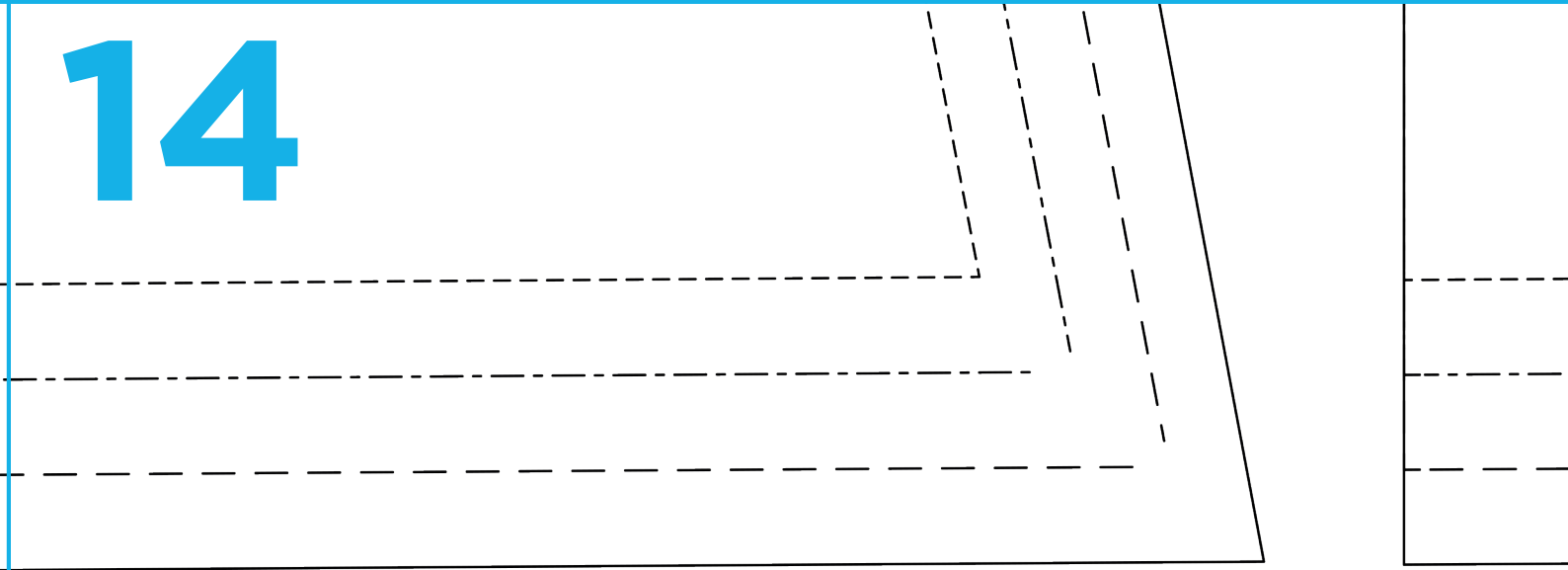

0 in/0 cm 1 in/2.5 cm 2 in/5 cm

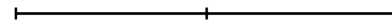

SCALE AT 100% SIZE (in inches)

15

5 cm 3 in/7.5 cm



(inches and centimeters)

16

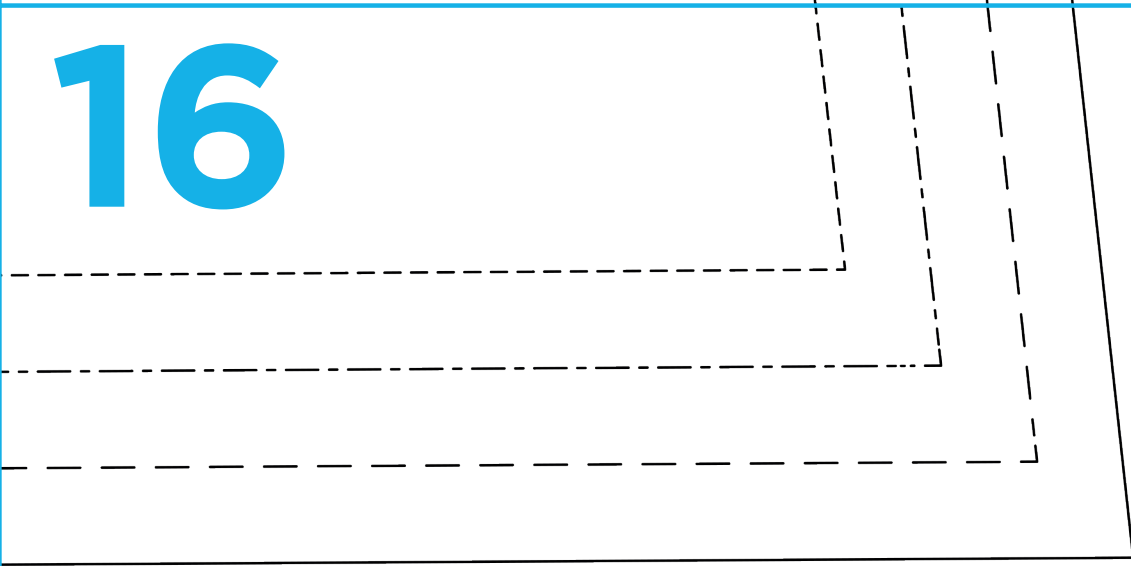

Page 19-21

Title: No-pattern dressing gown

Designer: Amanda Walker

Magazine page: 34

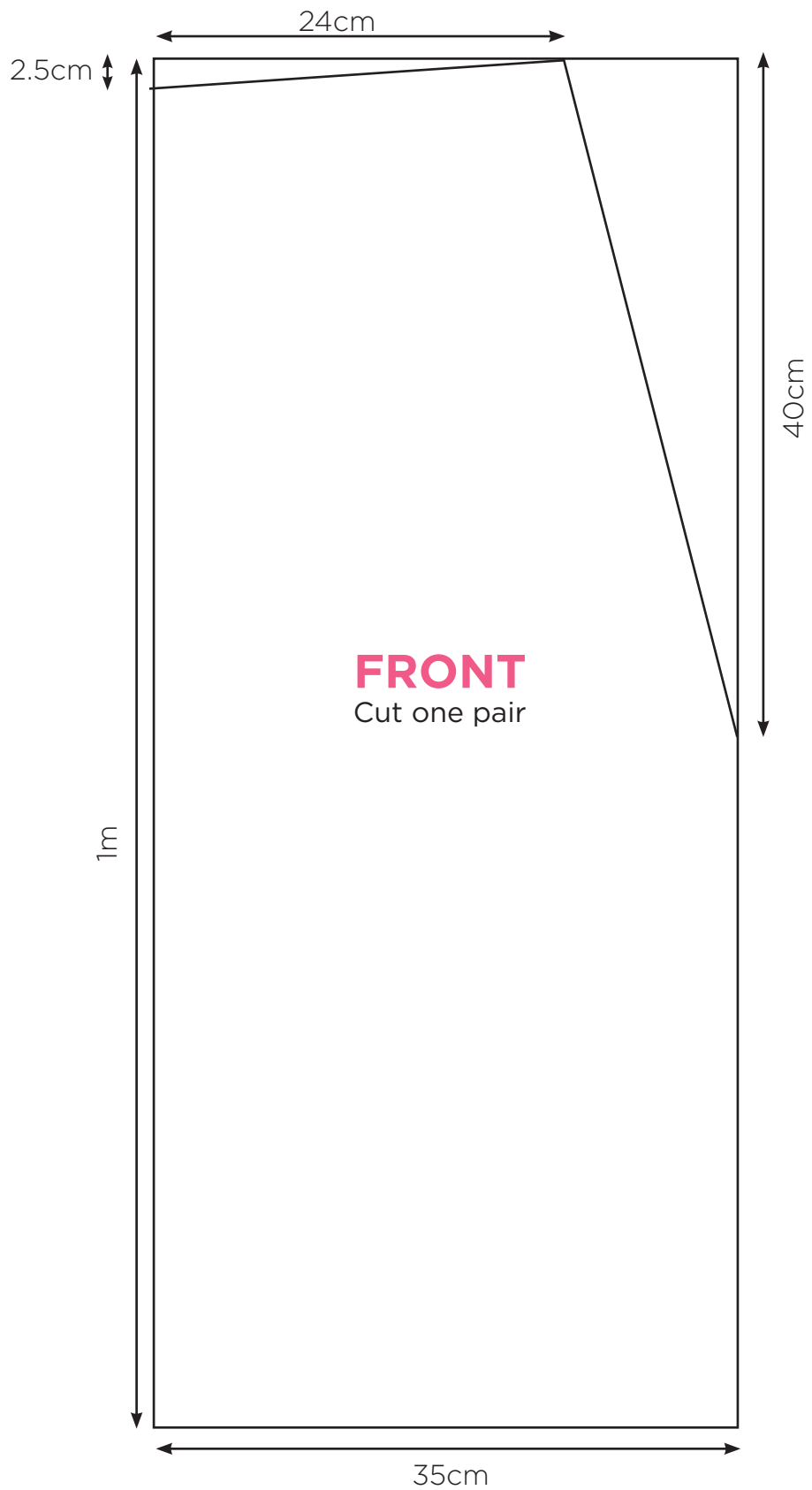

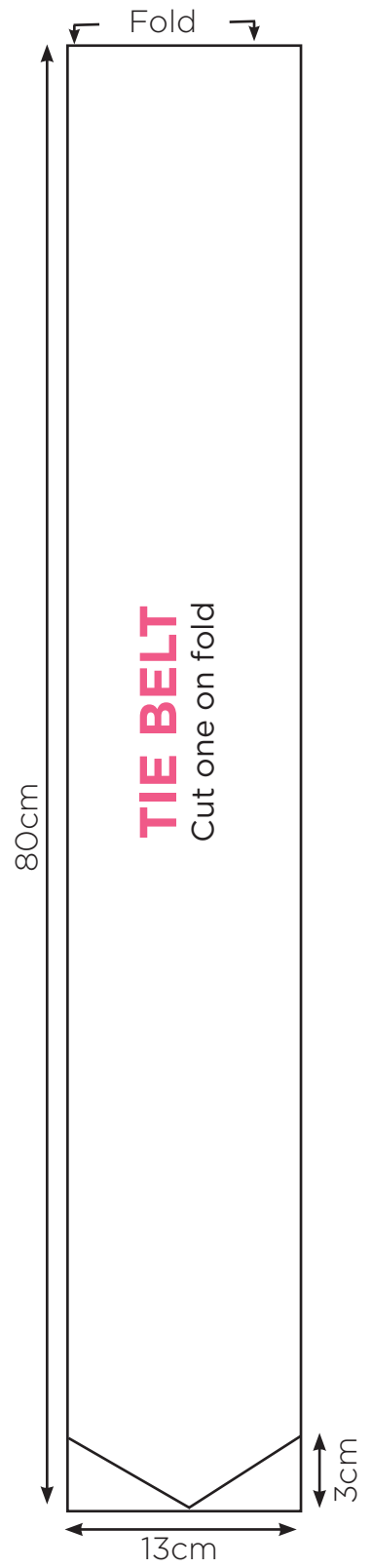
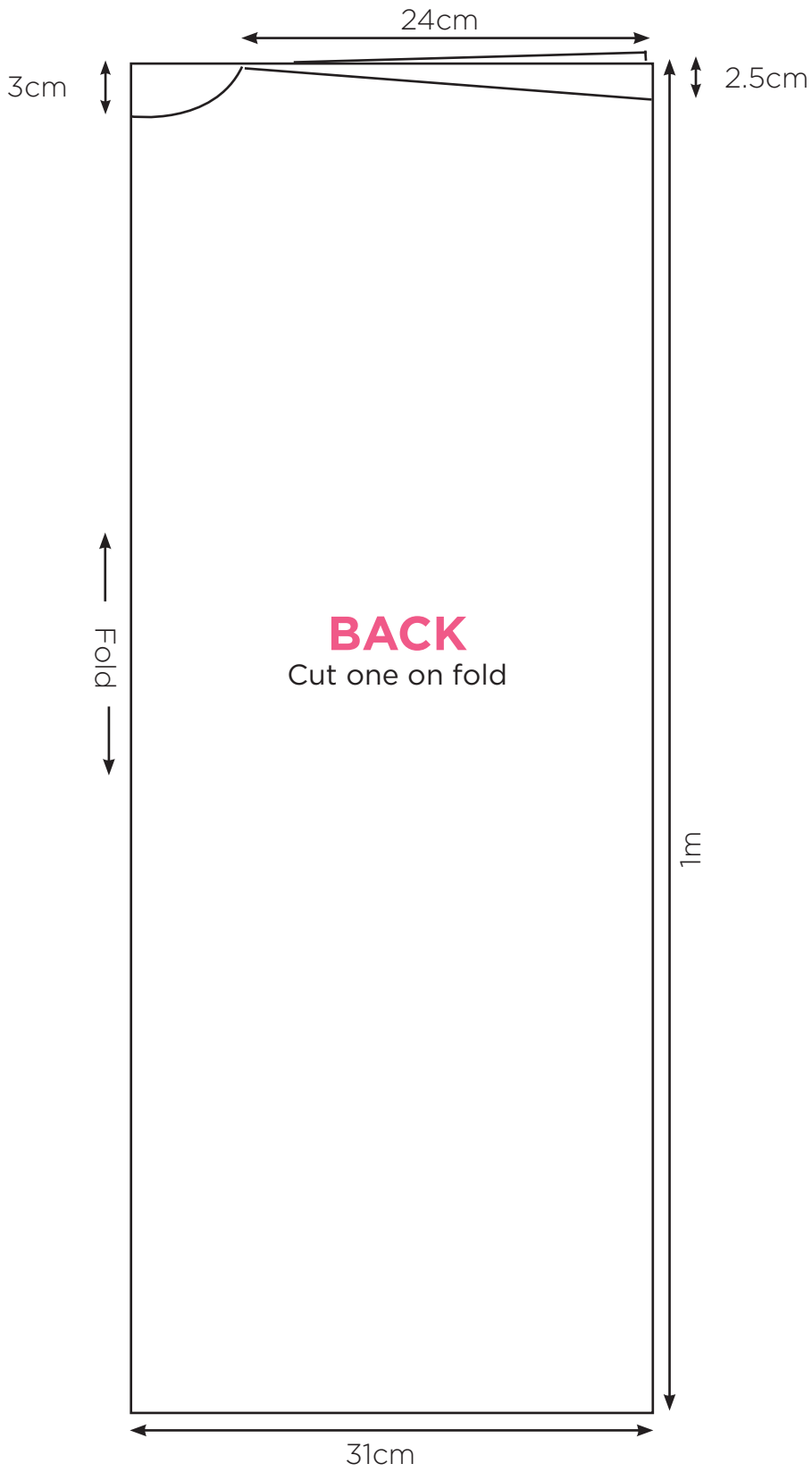

1.13m

NECK BAND
Cut two

13cm

60cm

SLEEVE
Cut two

30cm

SLEEVE BAND
Cut two

13cm

60cm

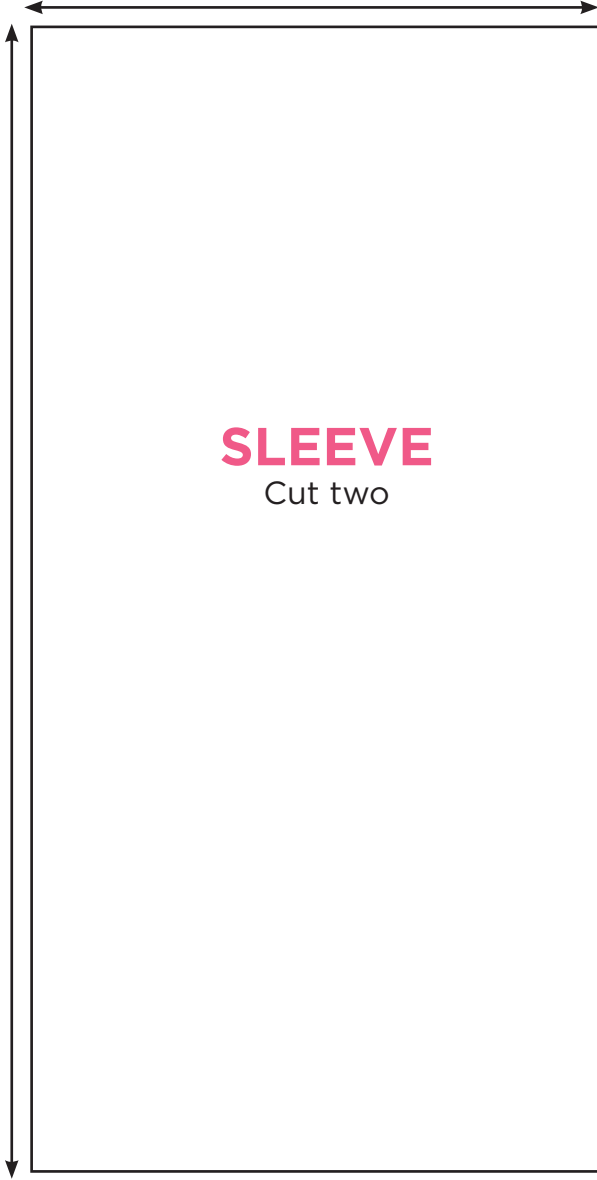

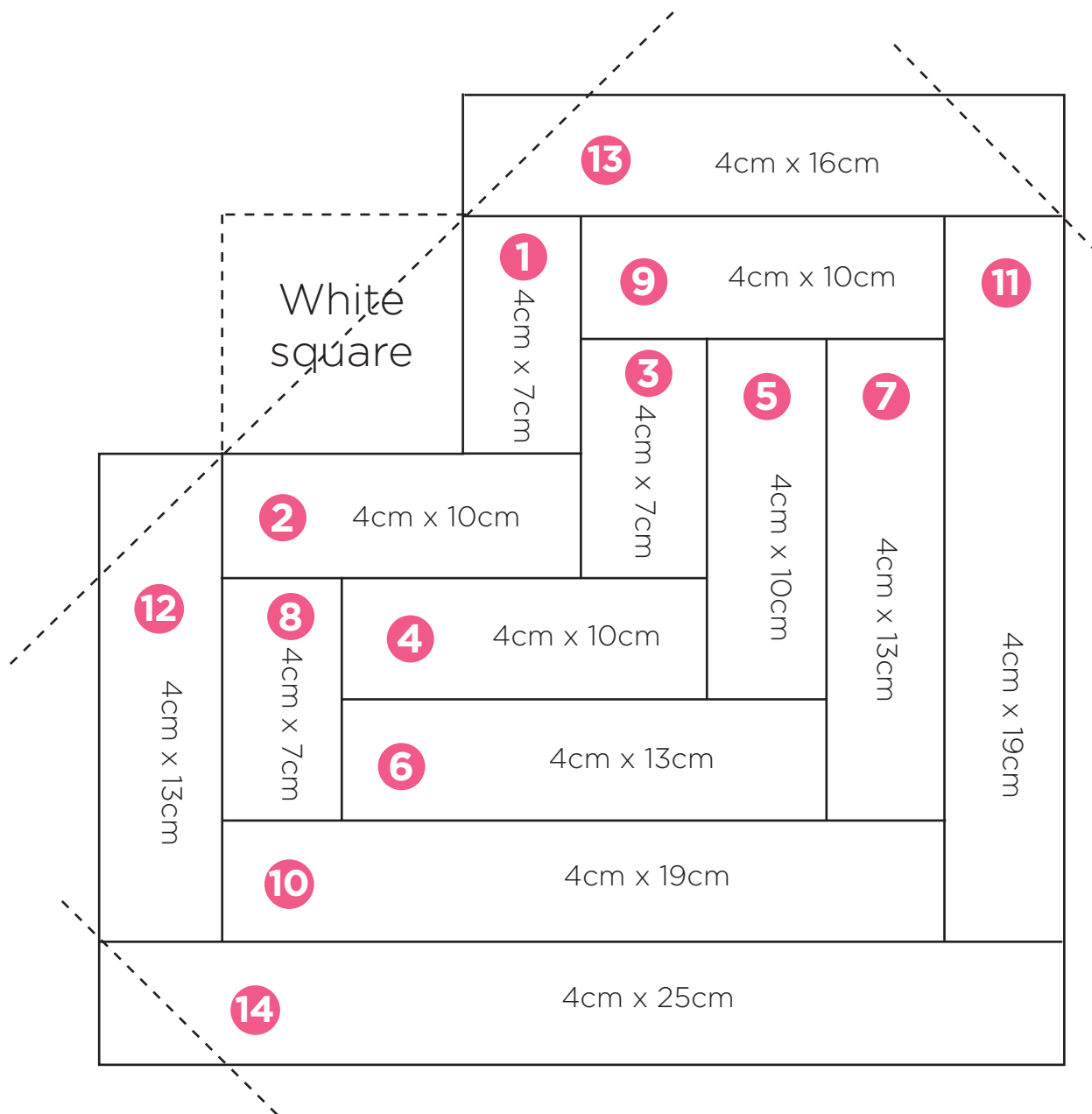

Crochet Hooks



Needles



Page 24-27

Title: Rucksack course

Designer: Debbie Von Grabler-Crozier

Magazine page: 70

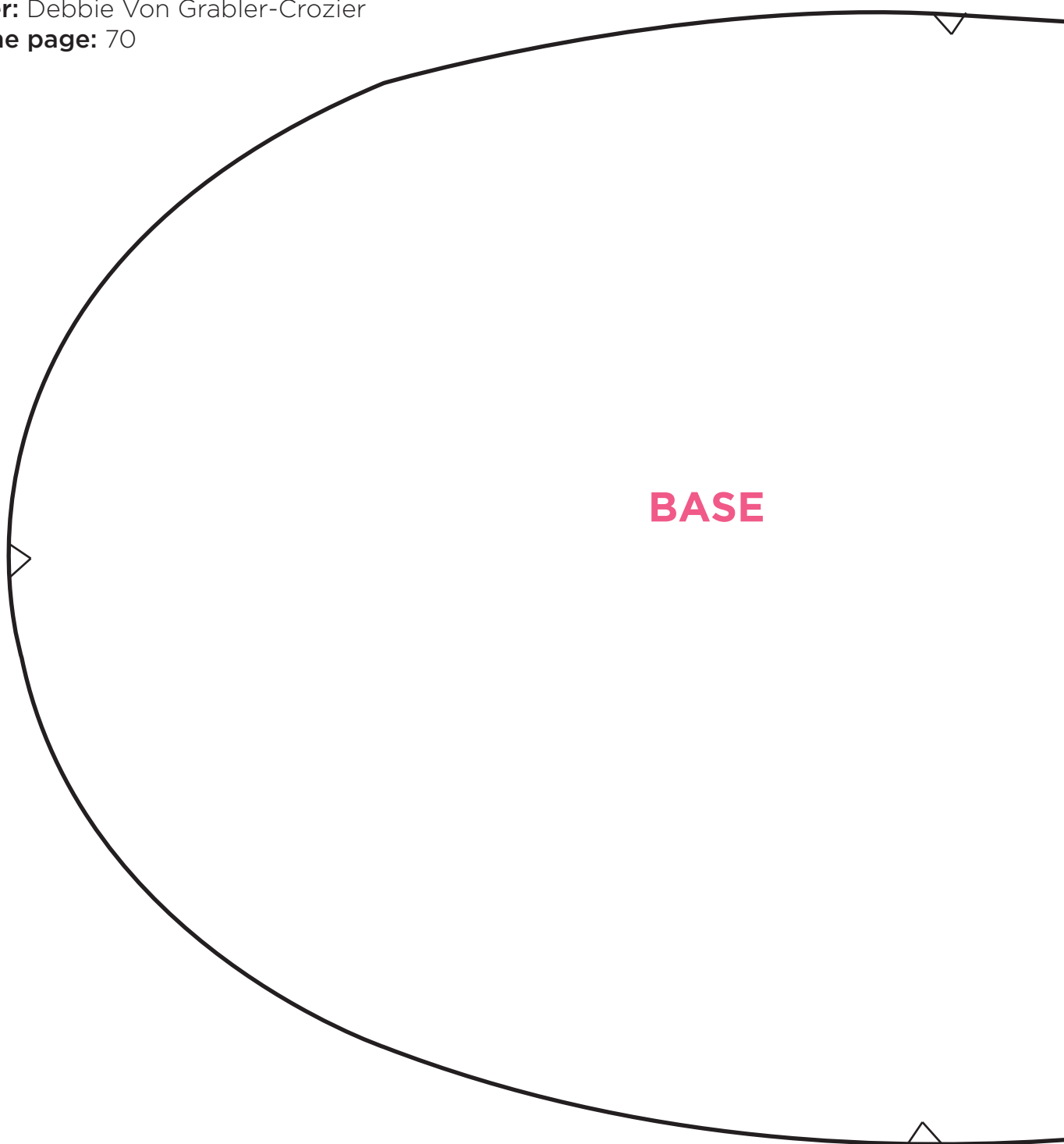

BASE

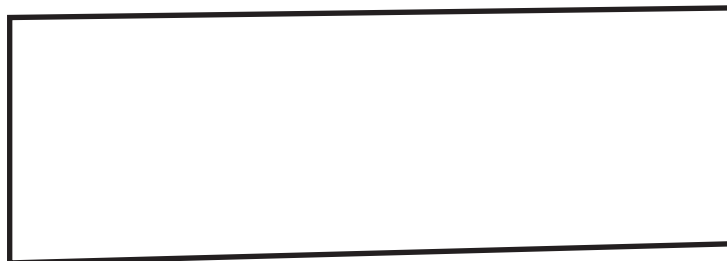

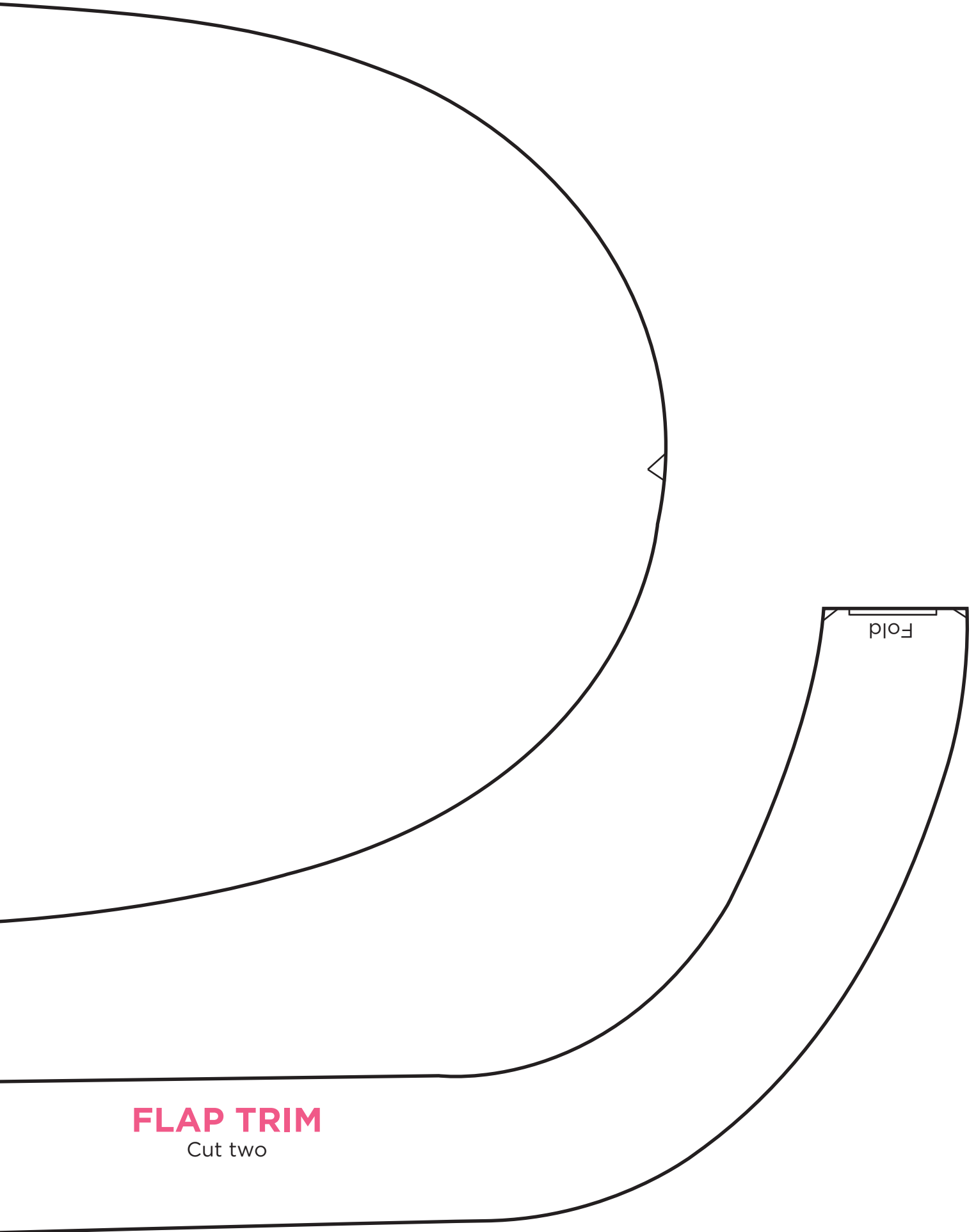

FLAP TRIM
Cut two

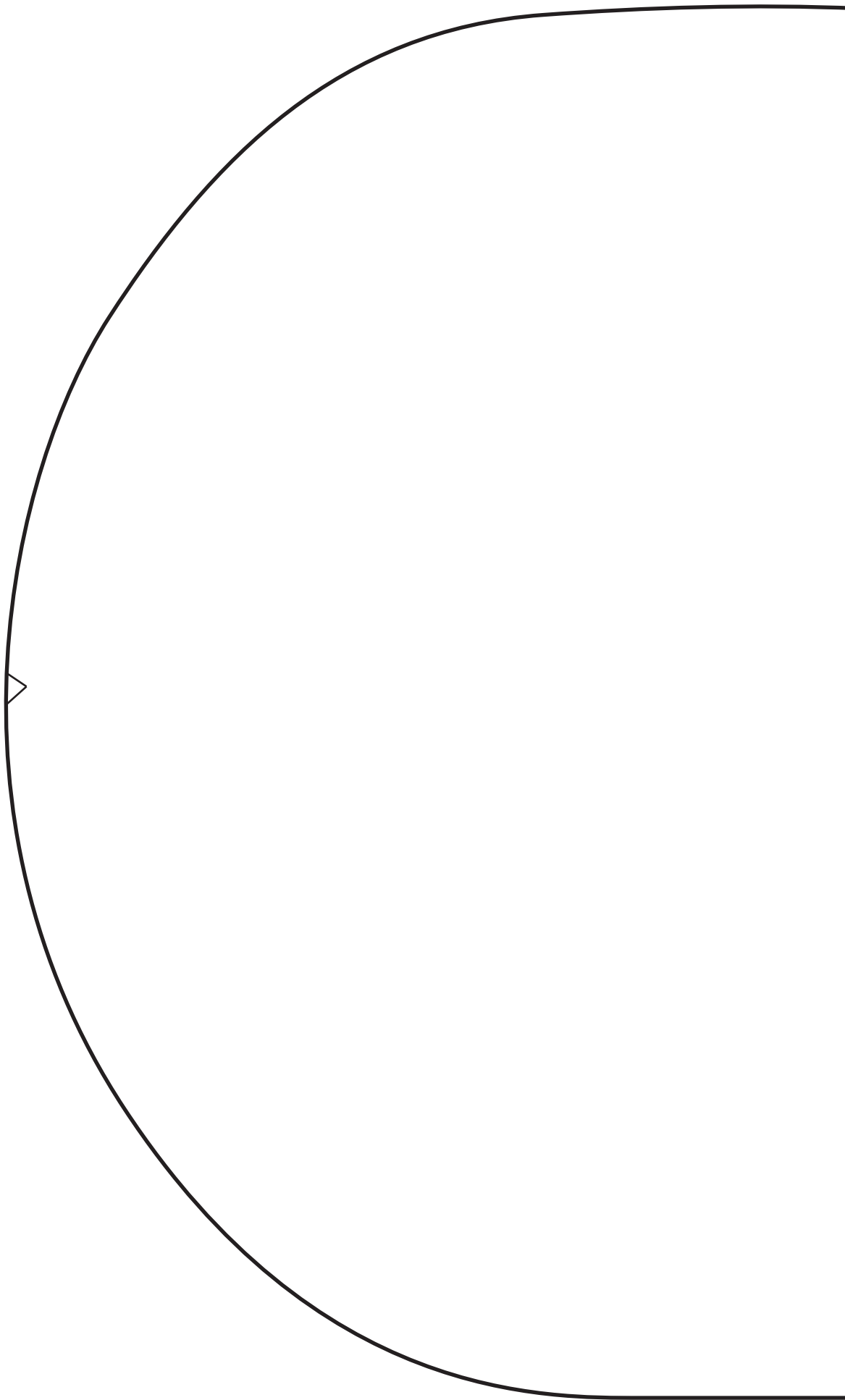



FLAP

Page 28-29

Title: Retro style apron

Designer: Ellen Kharade

Magazine page: 74

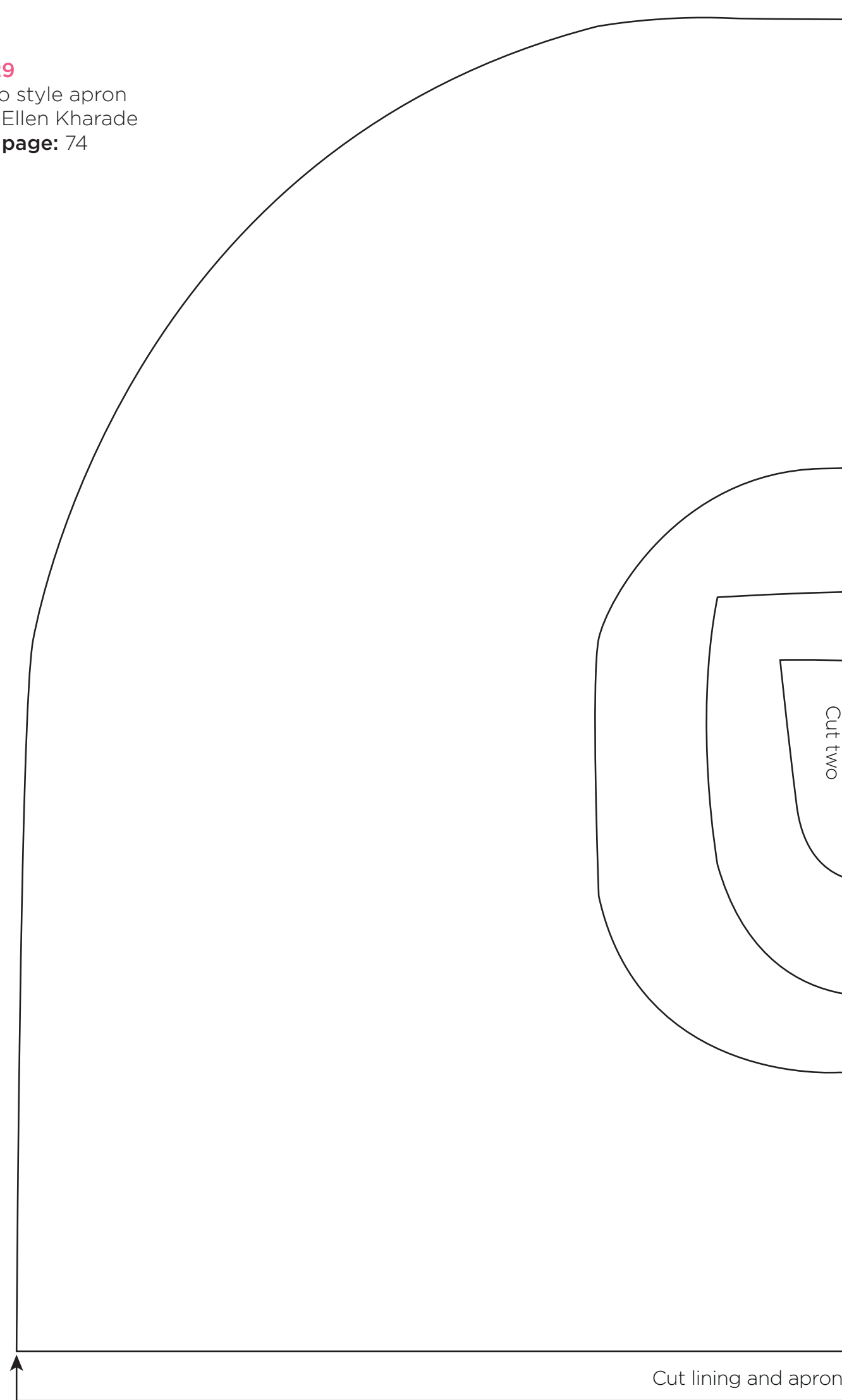

POCKET

Cut four

HEART

Cut one

**SMALL
HEART**



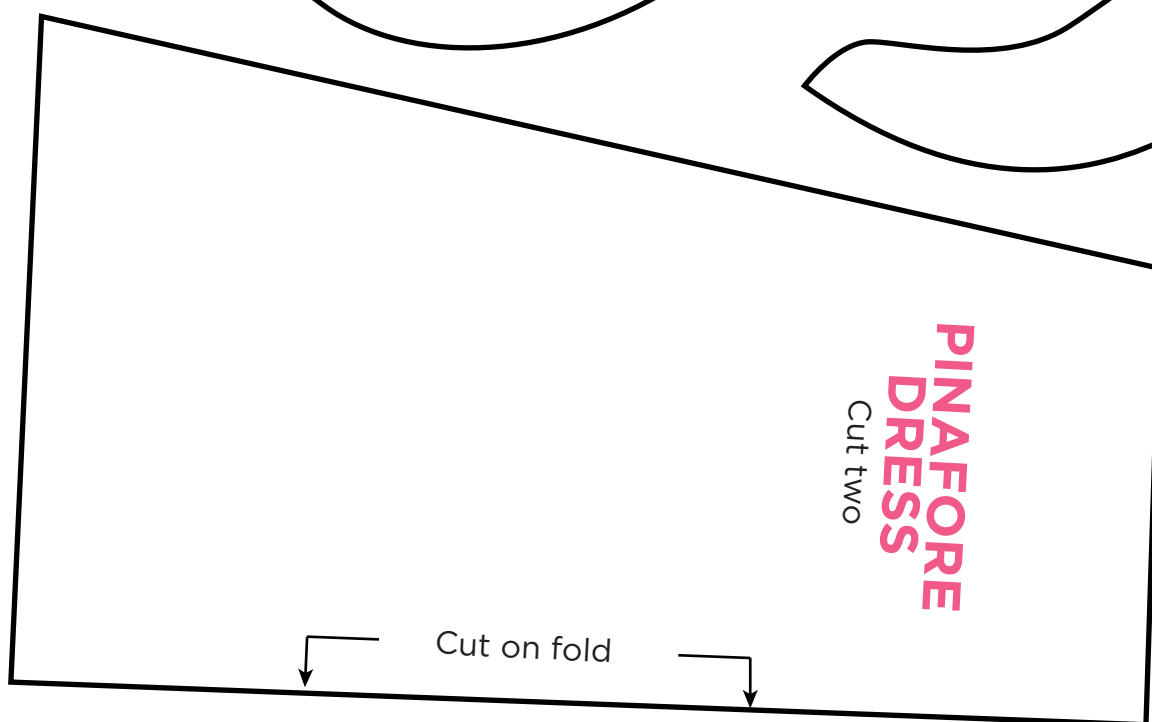
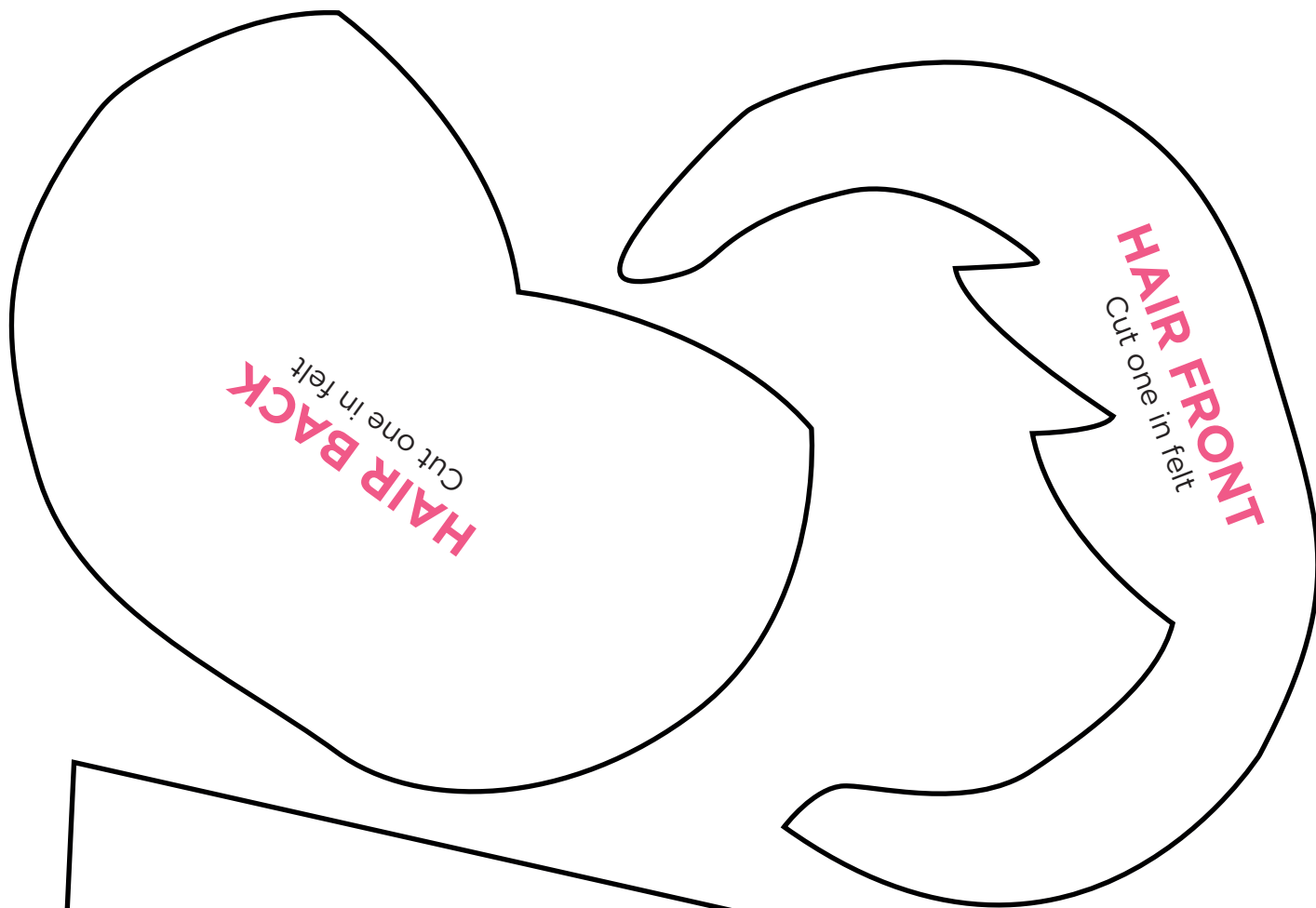

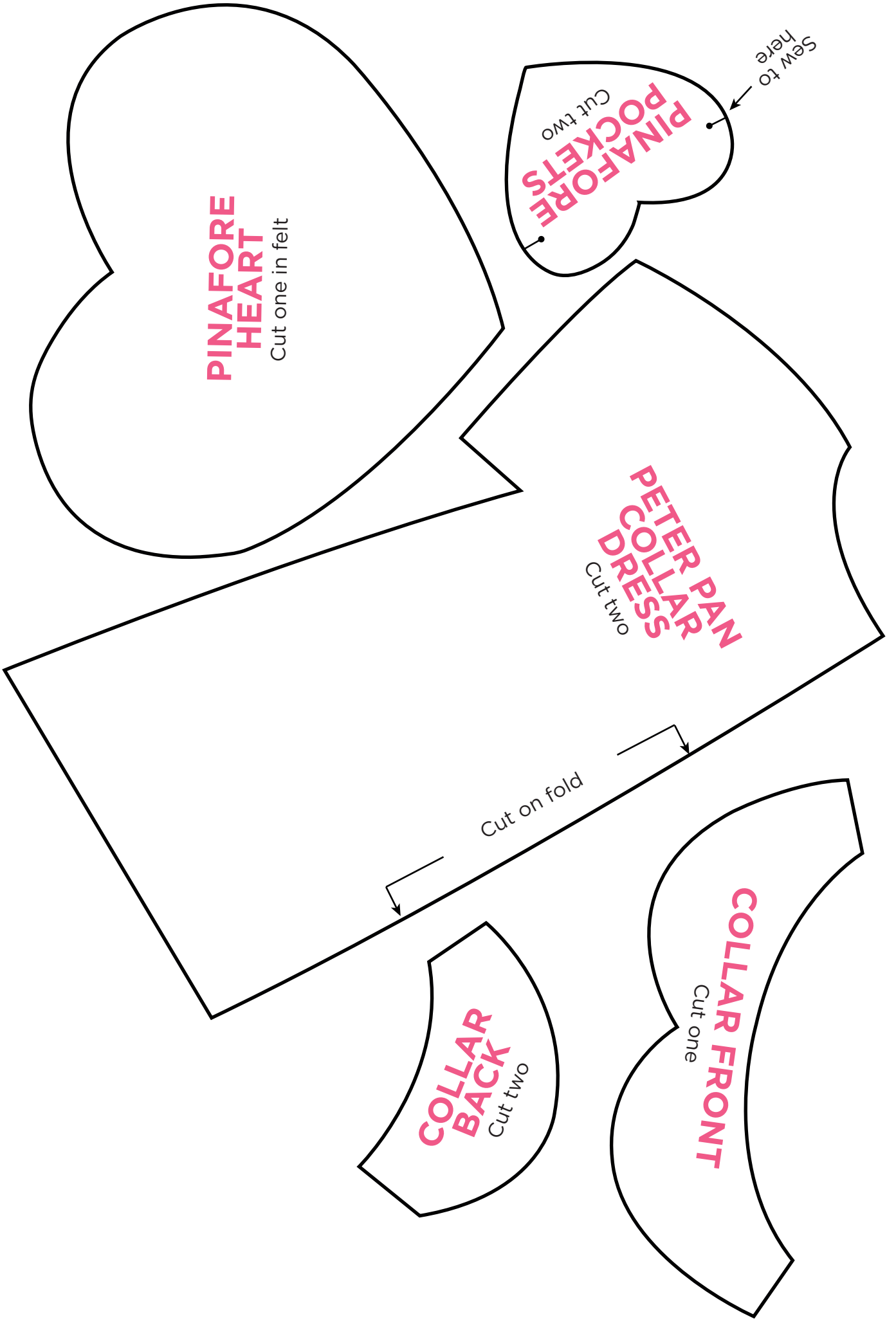

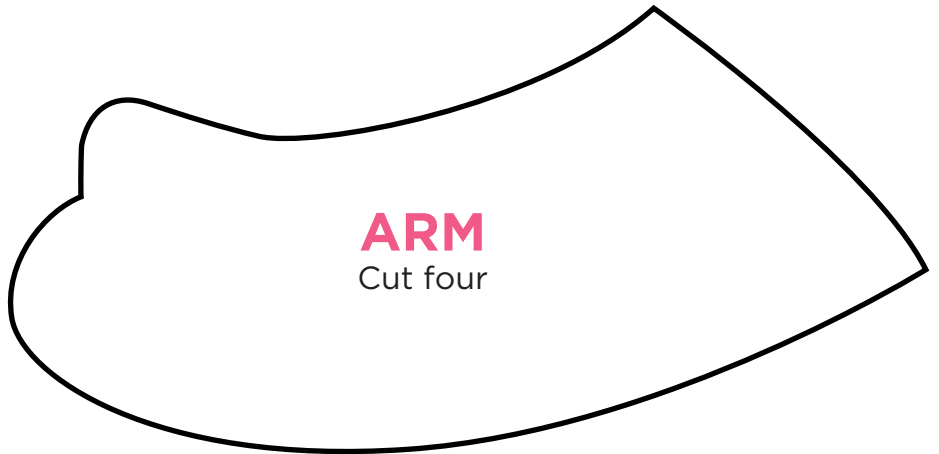
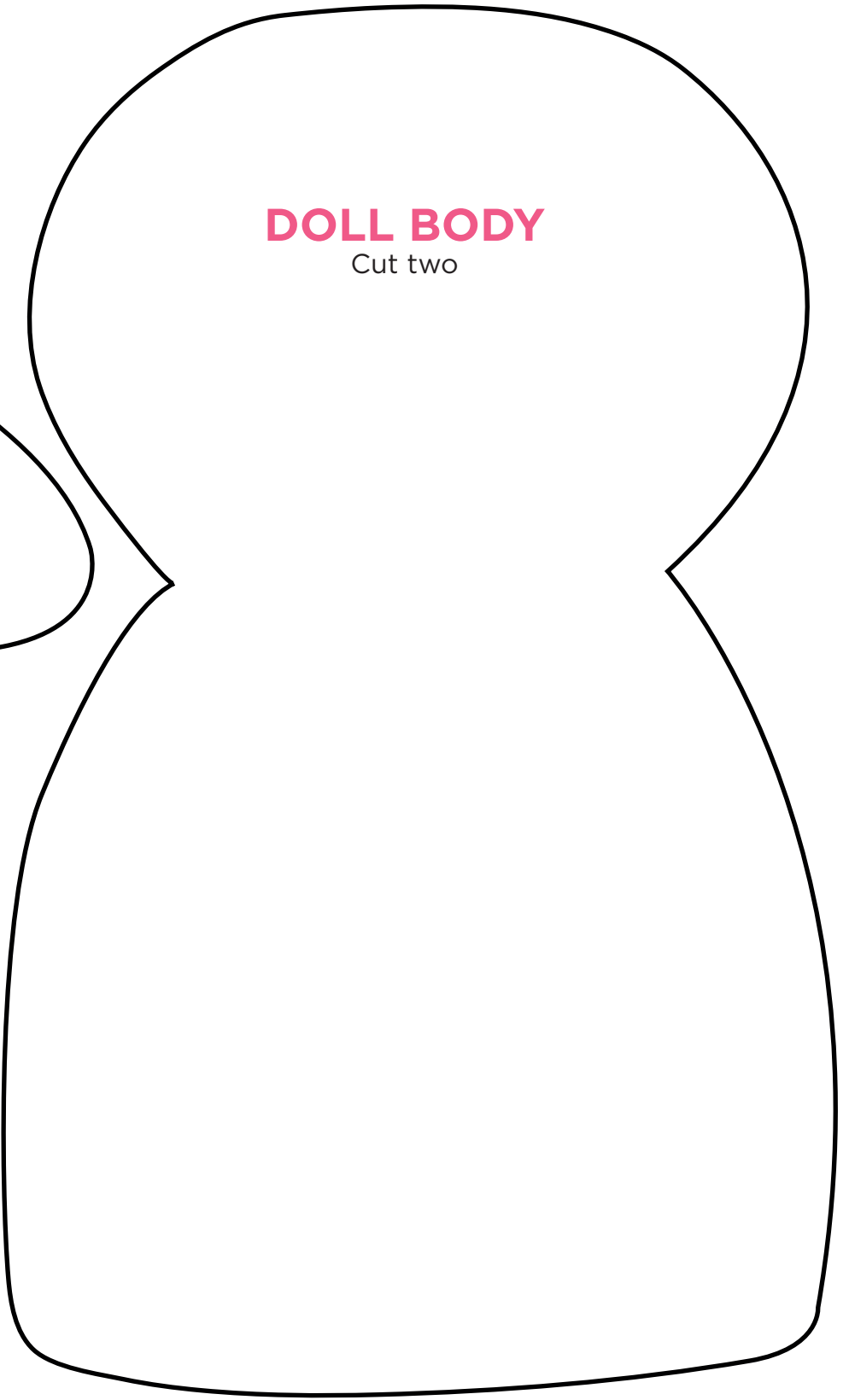
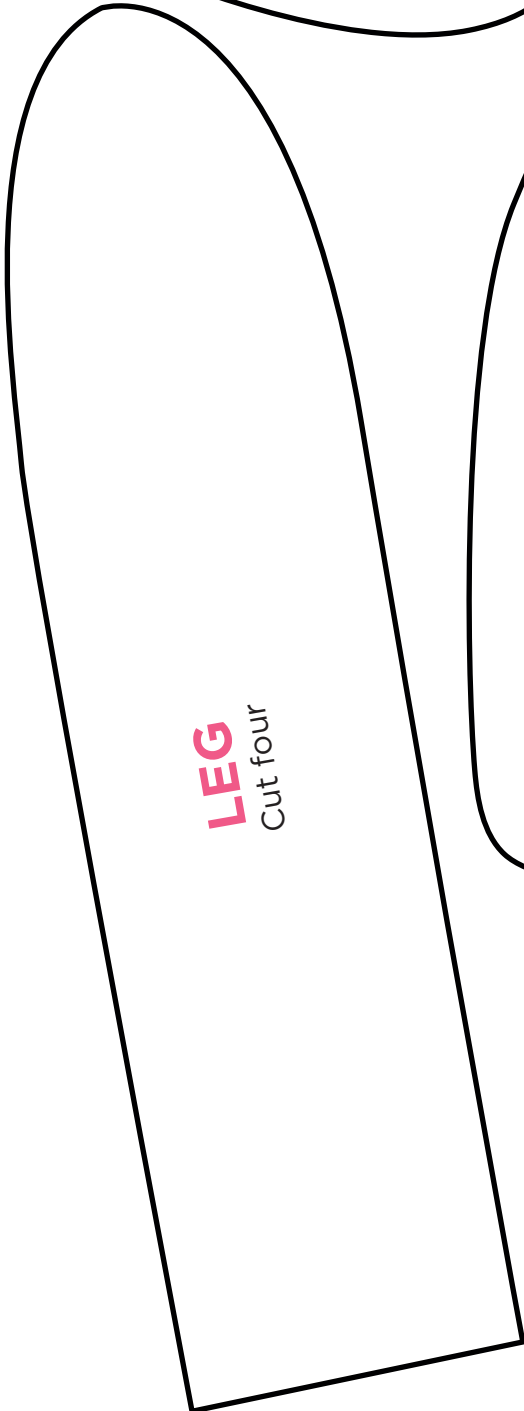
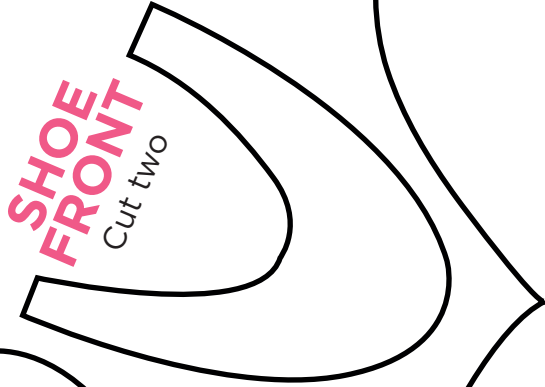
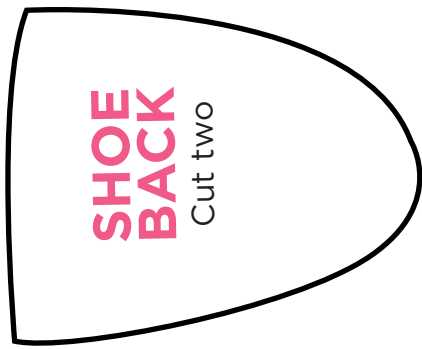

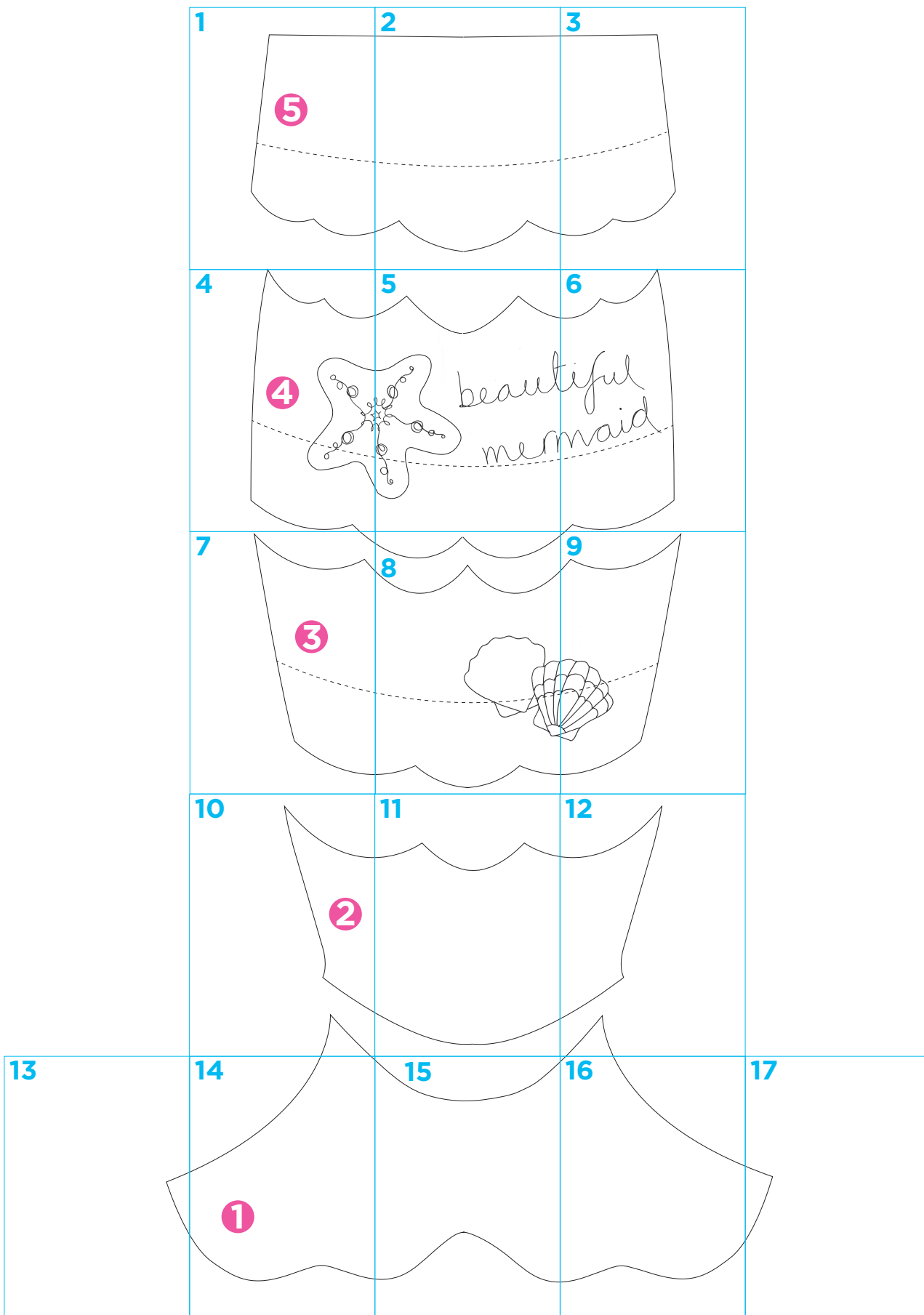

1

5

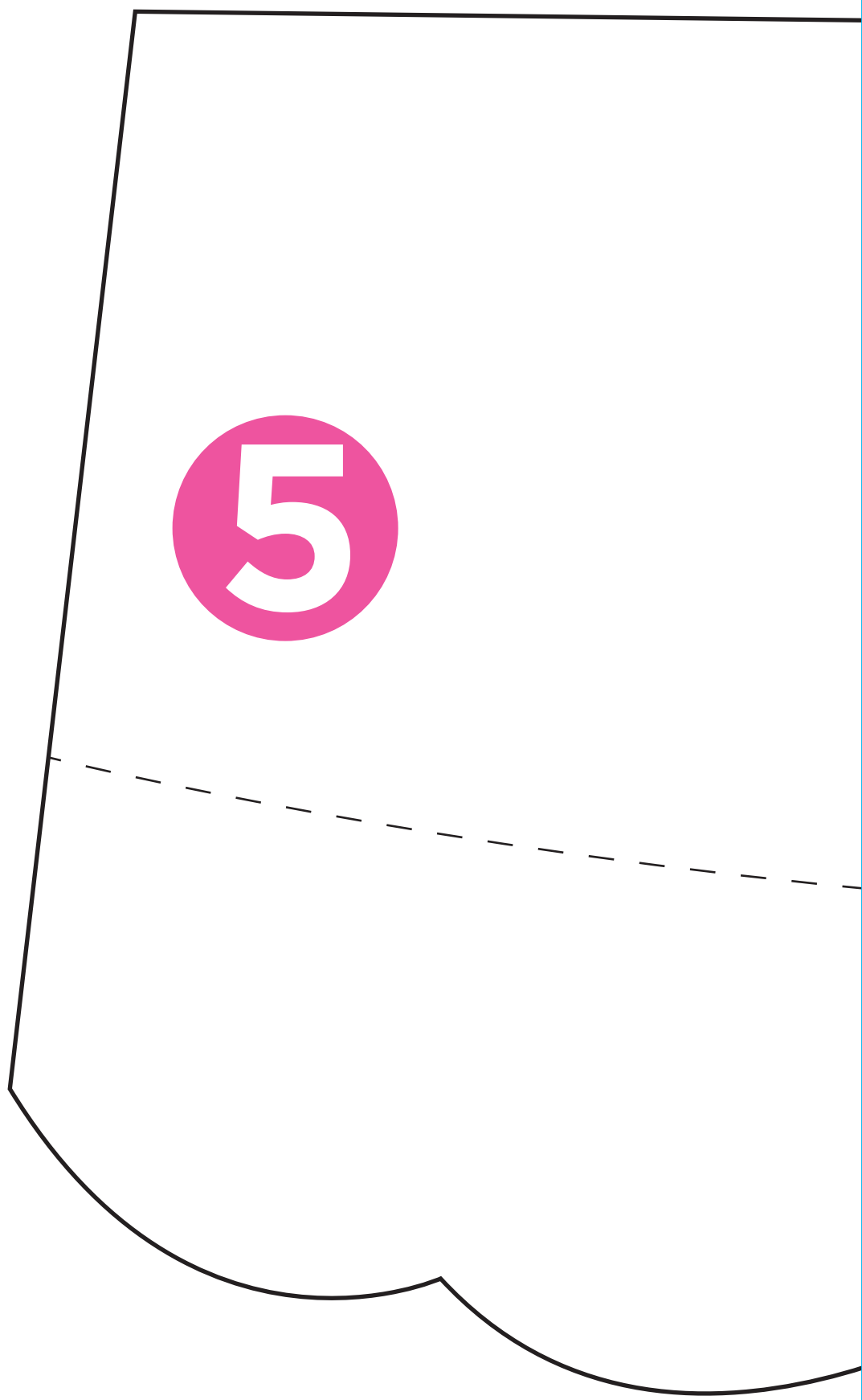

2

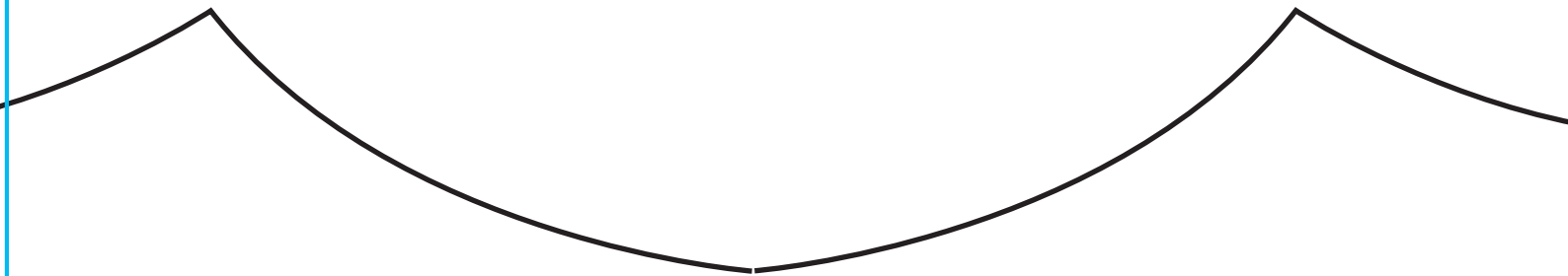

3

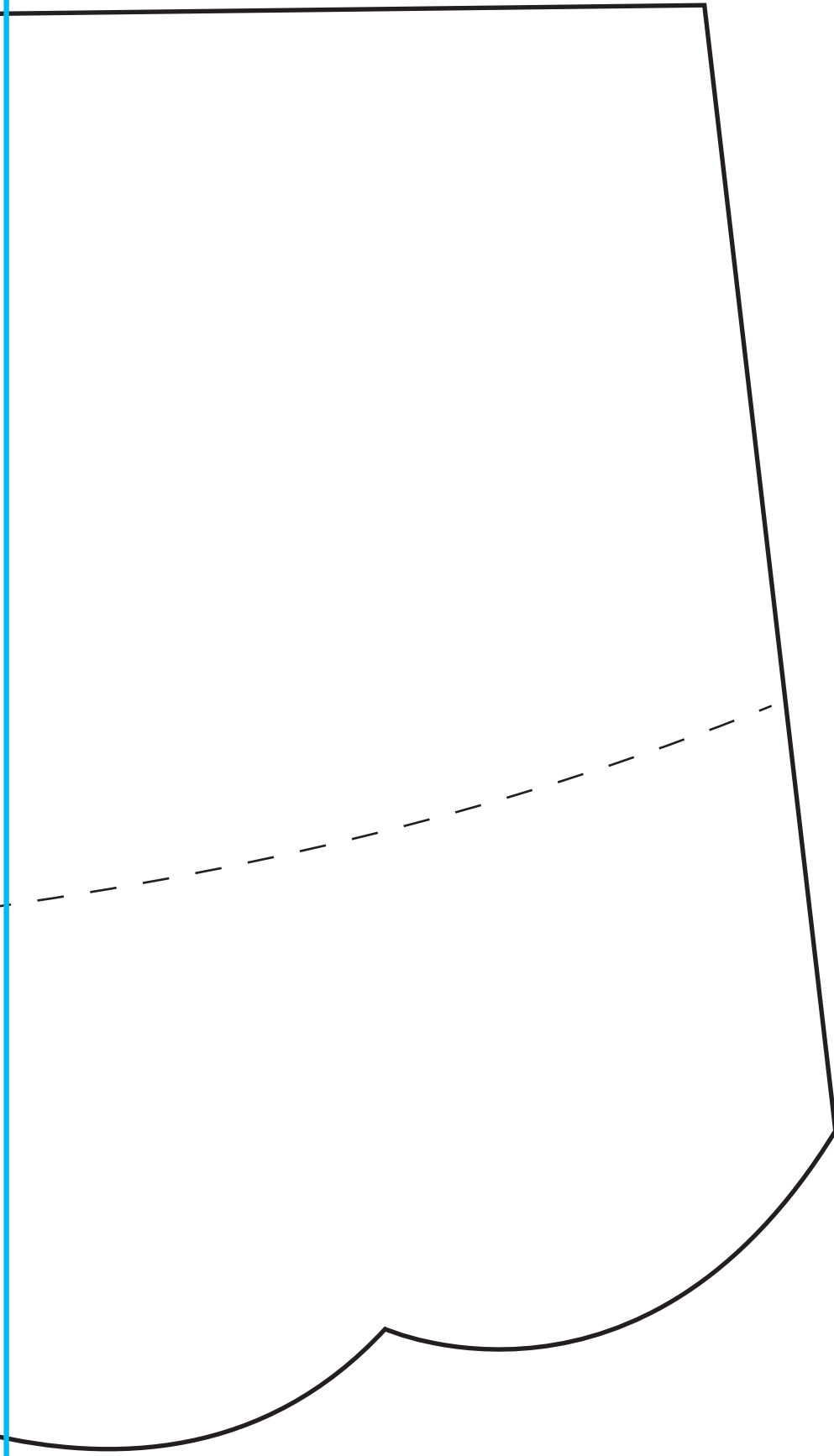

4

4



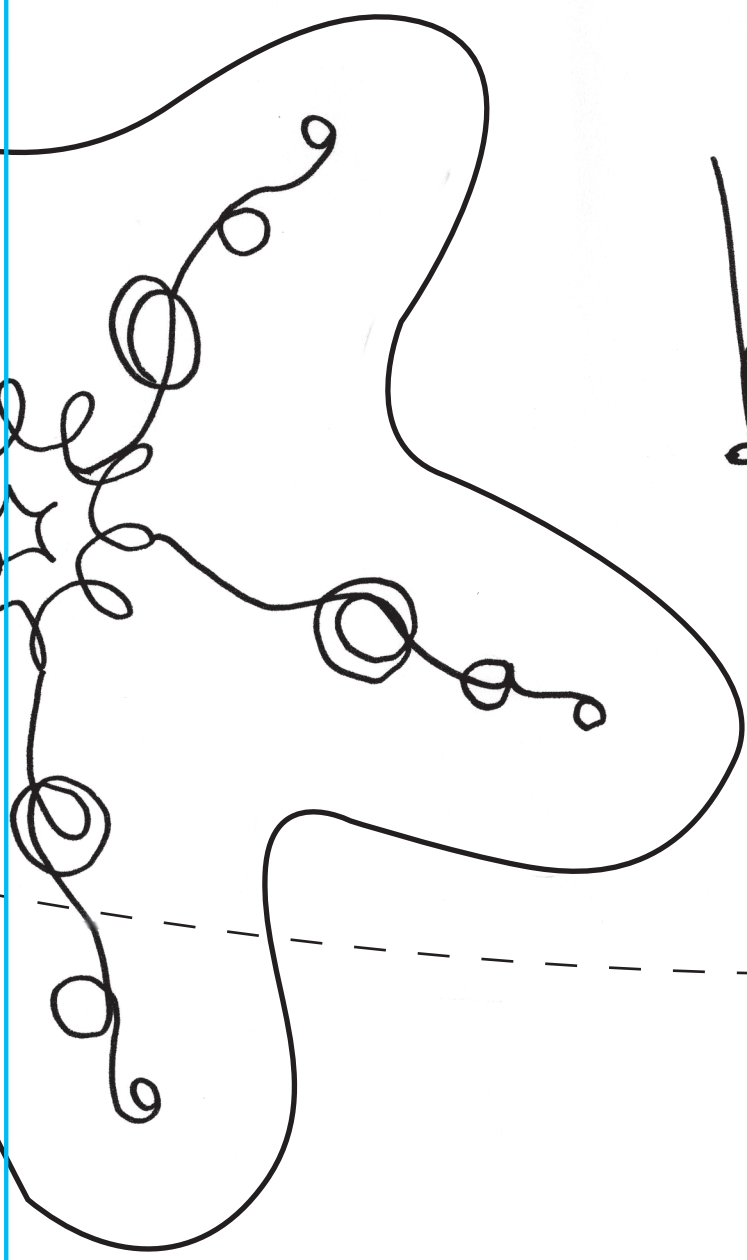
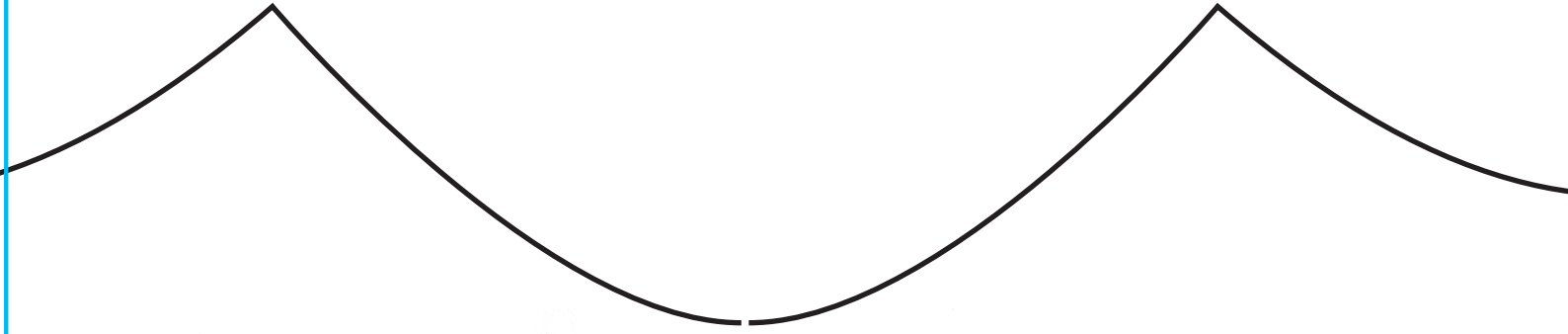

beaut

men



6

Beautiful
maid

7

3

8

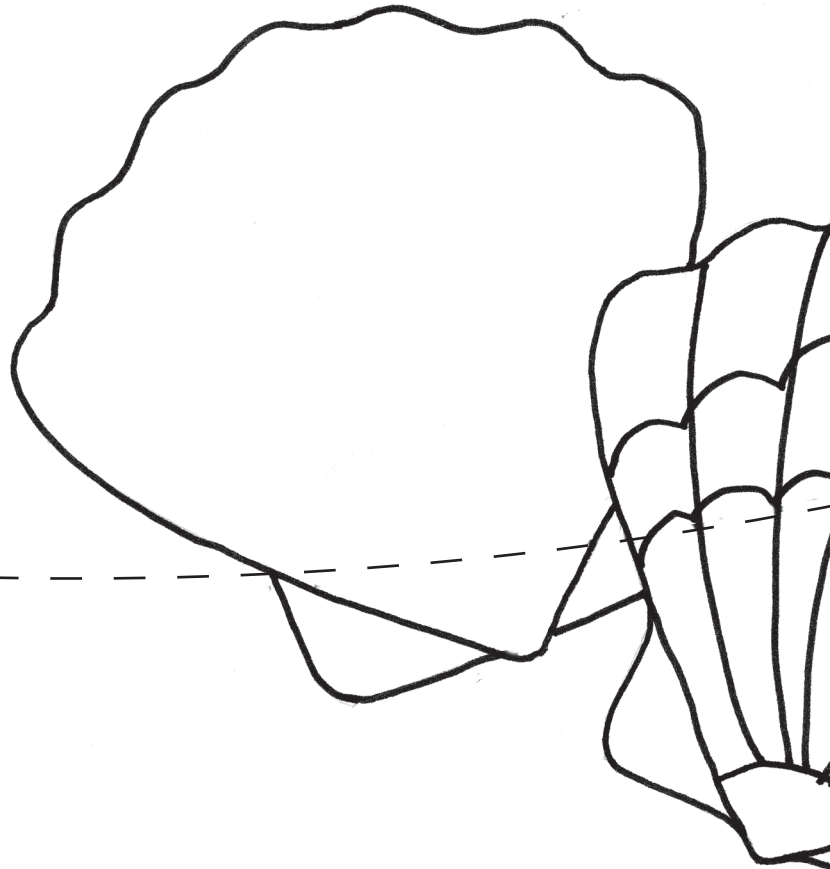

9

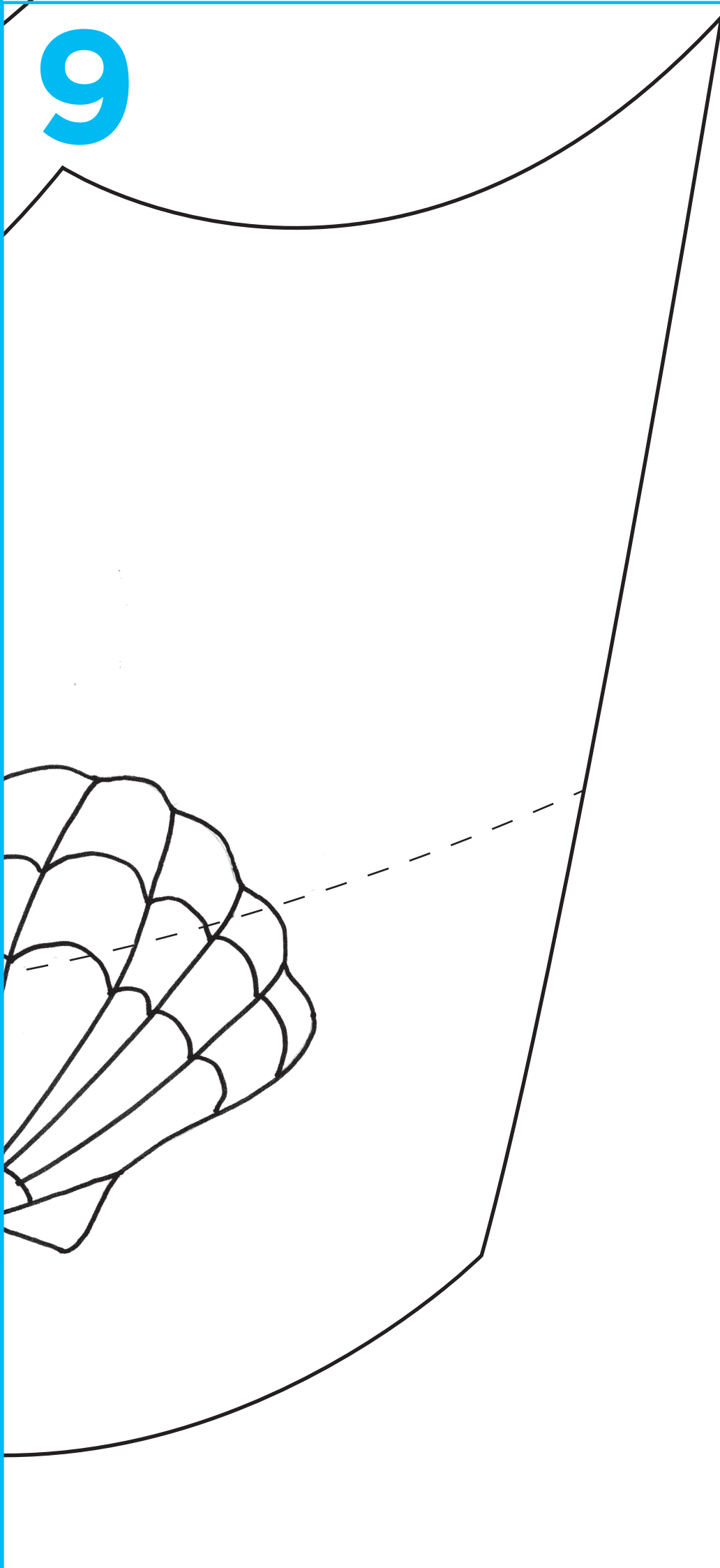

10



2

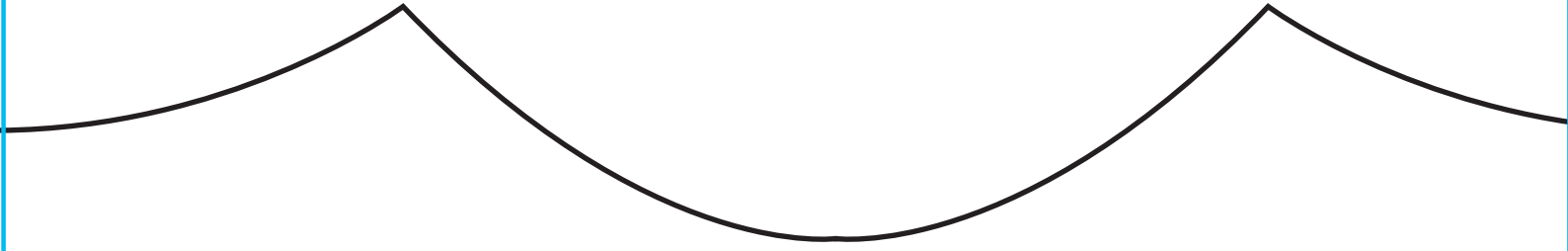

12

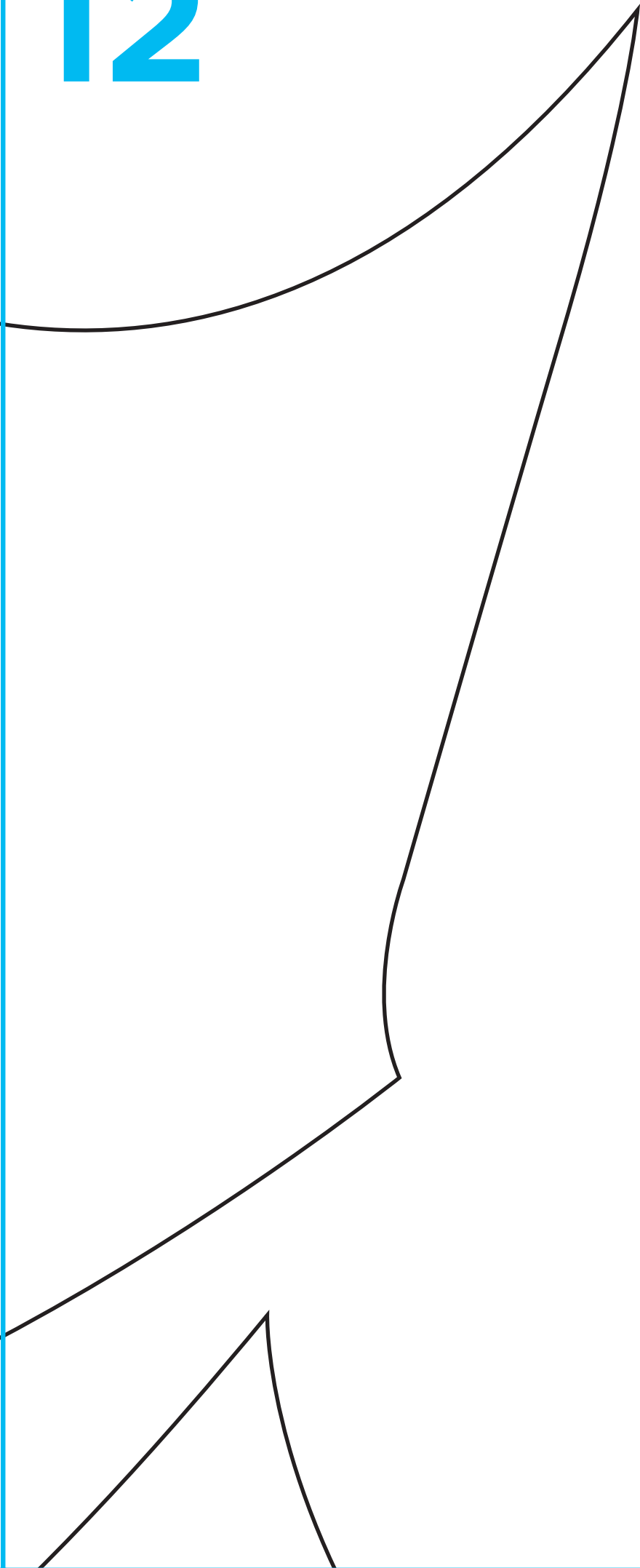

13



14

1

15

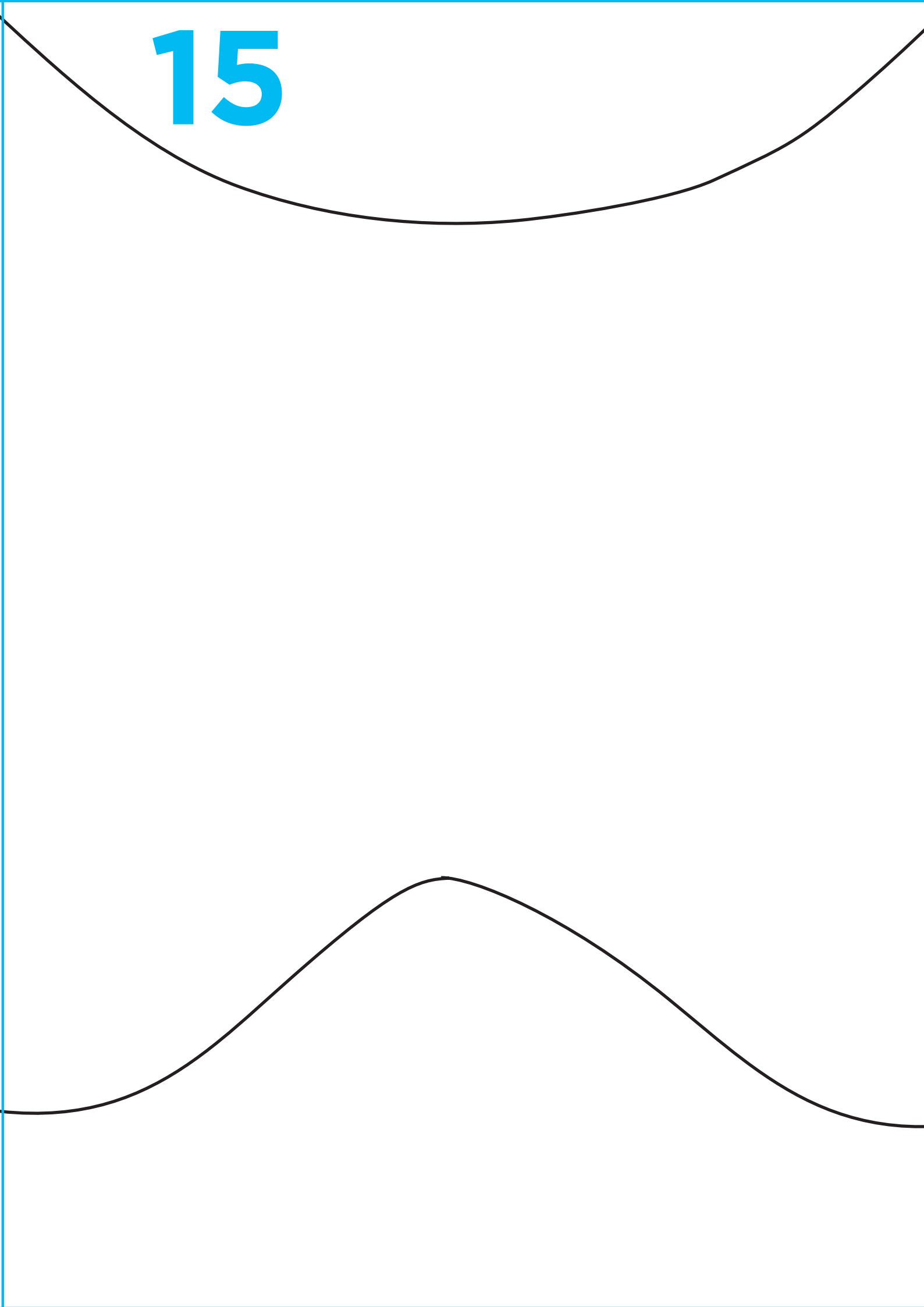

16

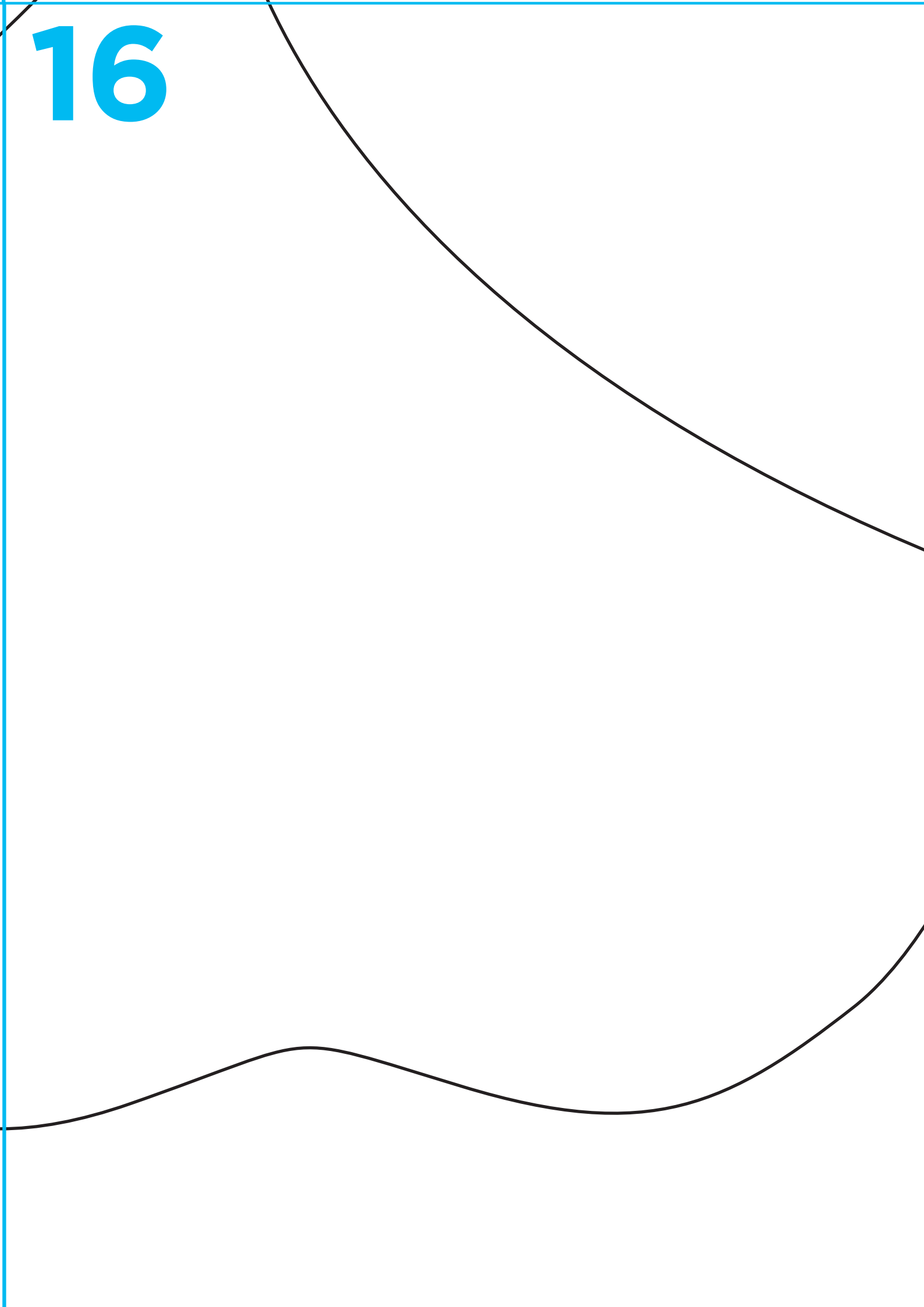

17

