

HOW TO PRINT THIS PATTERN

Print out this 30-page PDF on to A4 paper. Trim away the shaded border from each page and position the pages as below to assemble the pattern...

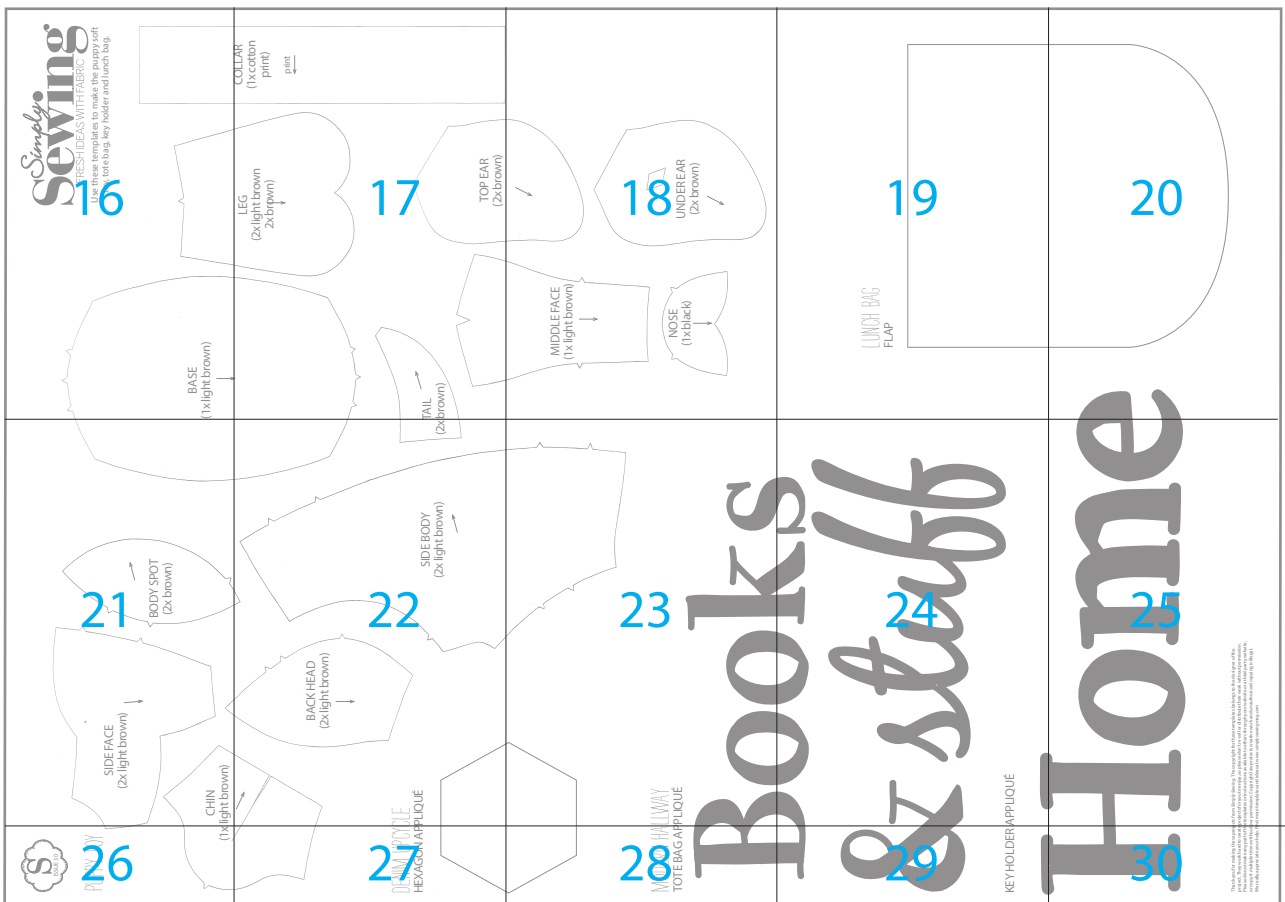

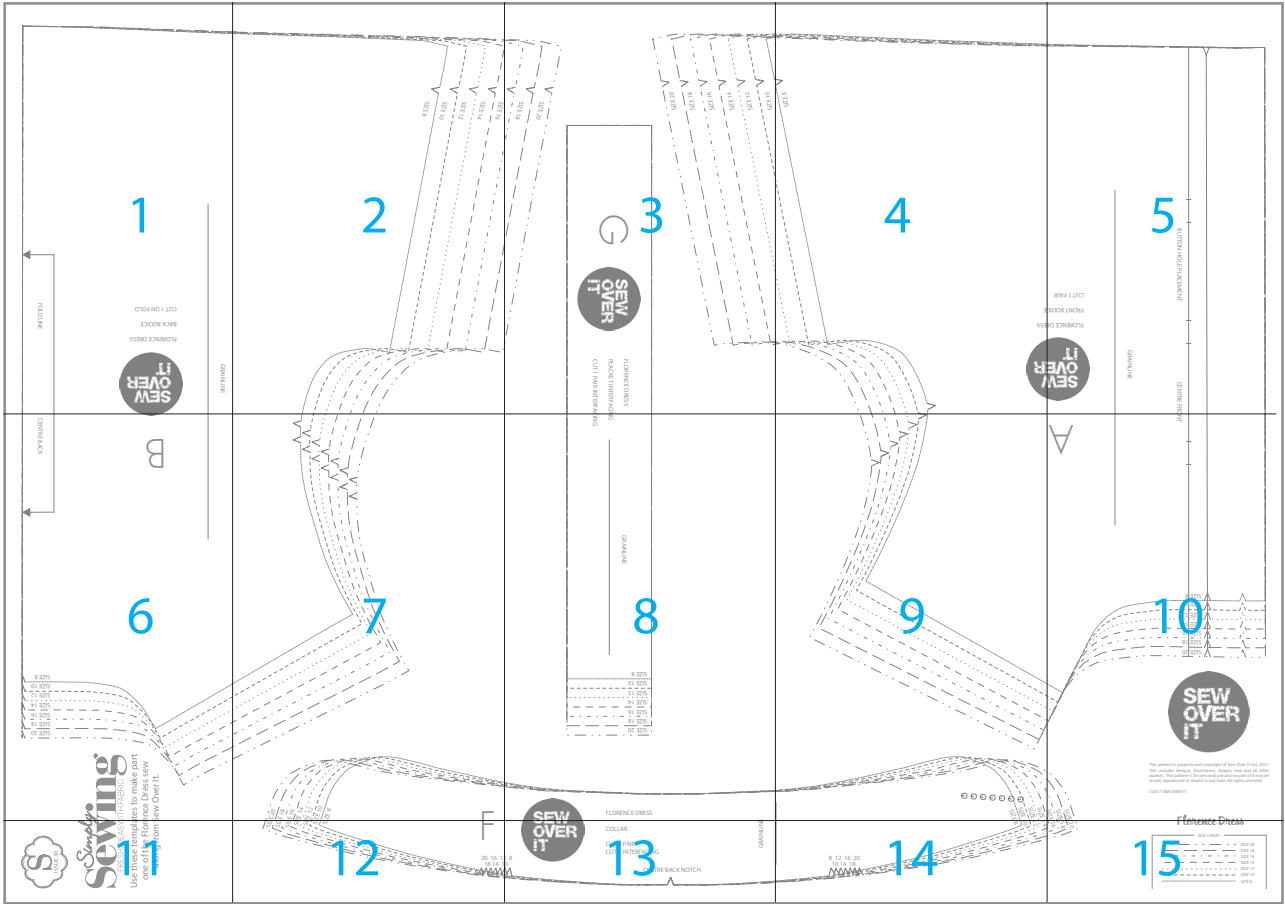

FLORENCE DRESS

BACK BODICE

CUT 1 ON FOLD

GRAINLINE

FOLDLINE

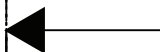

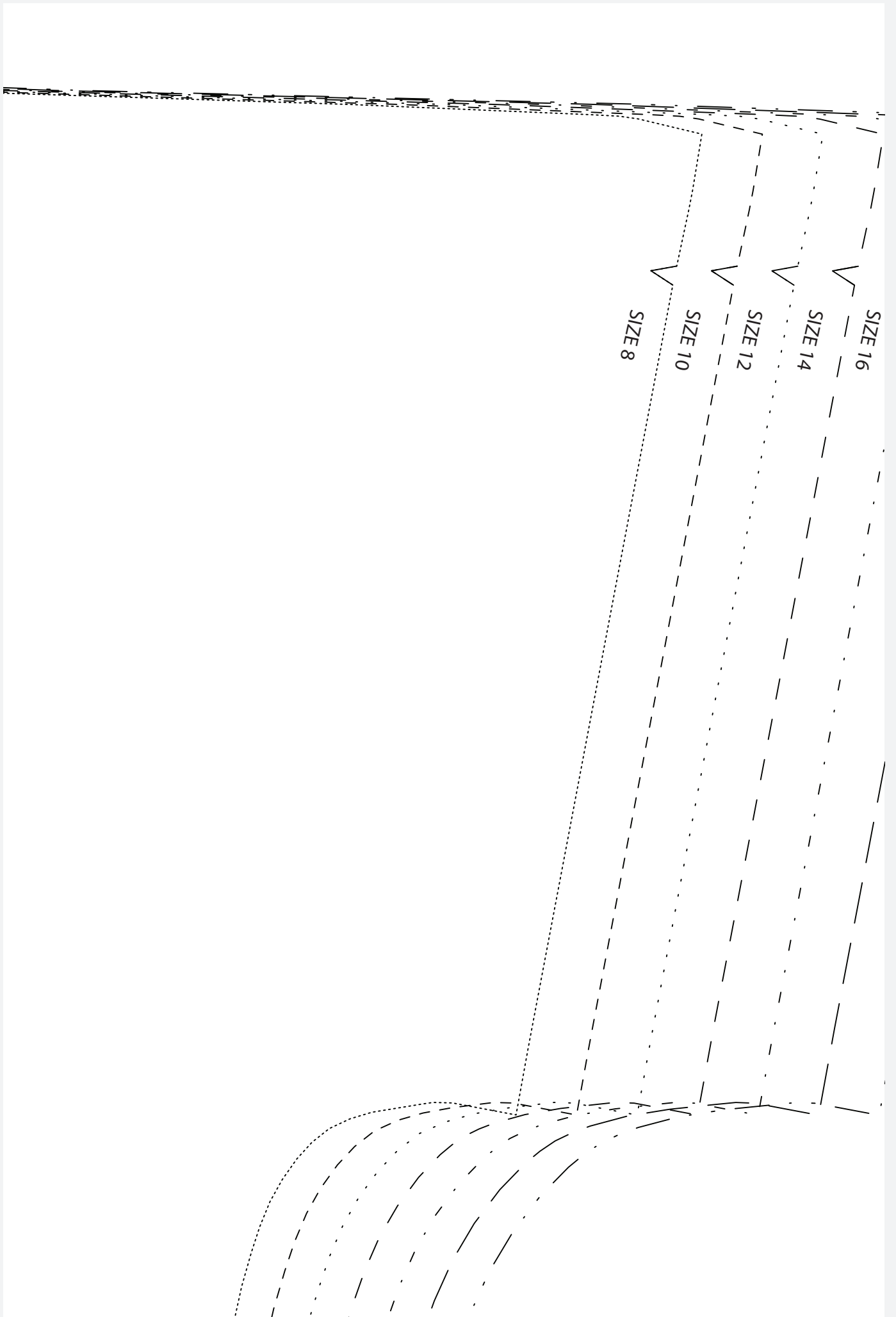

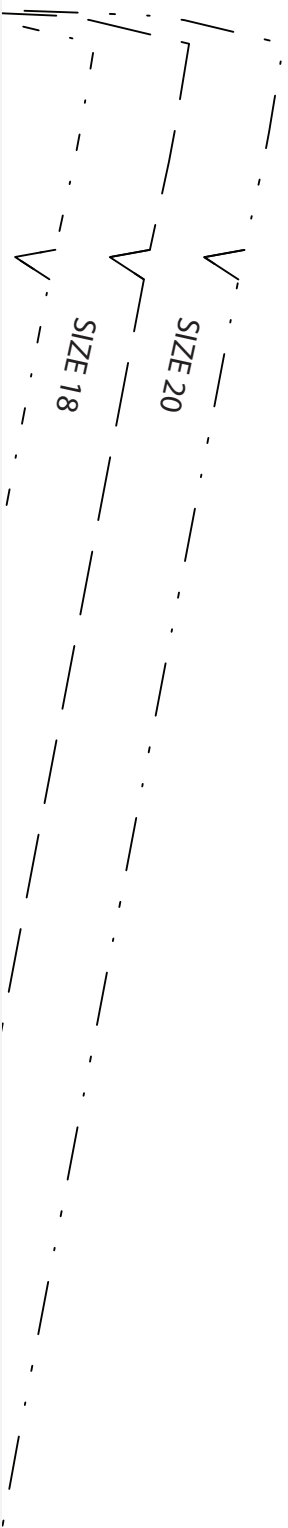
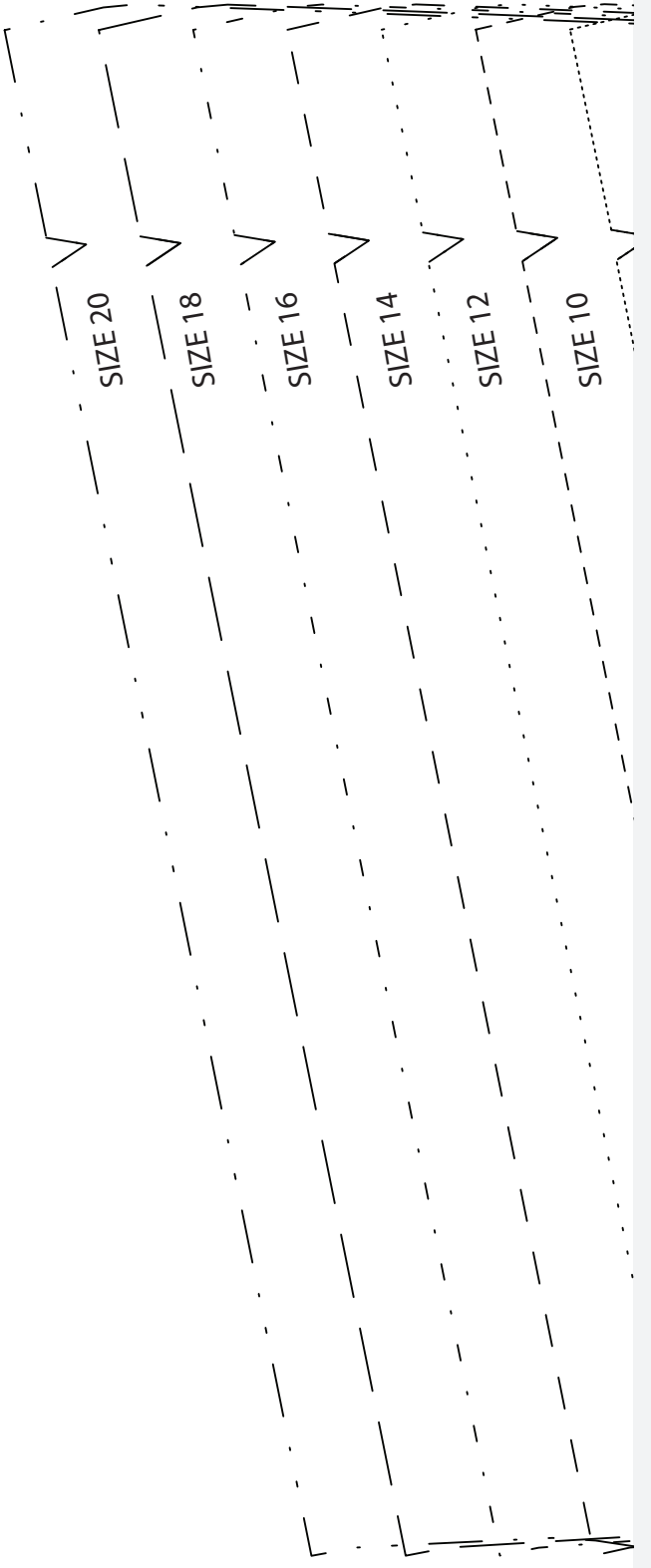

FLORENCE DRESS
PLACKET INTERFACIN
CUT 1 PAIR INTERFAC

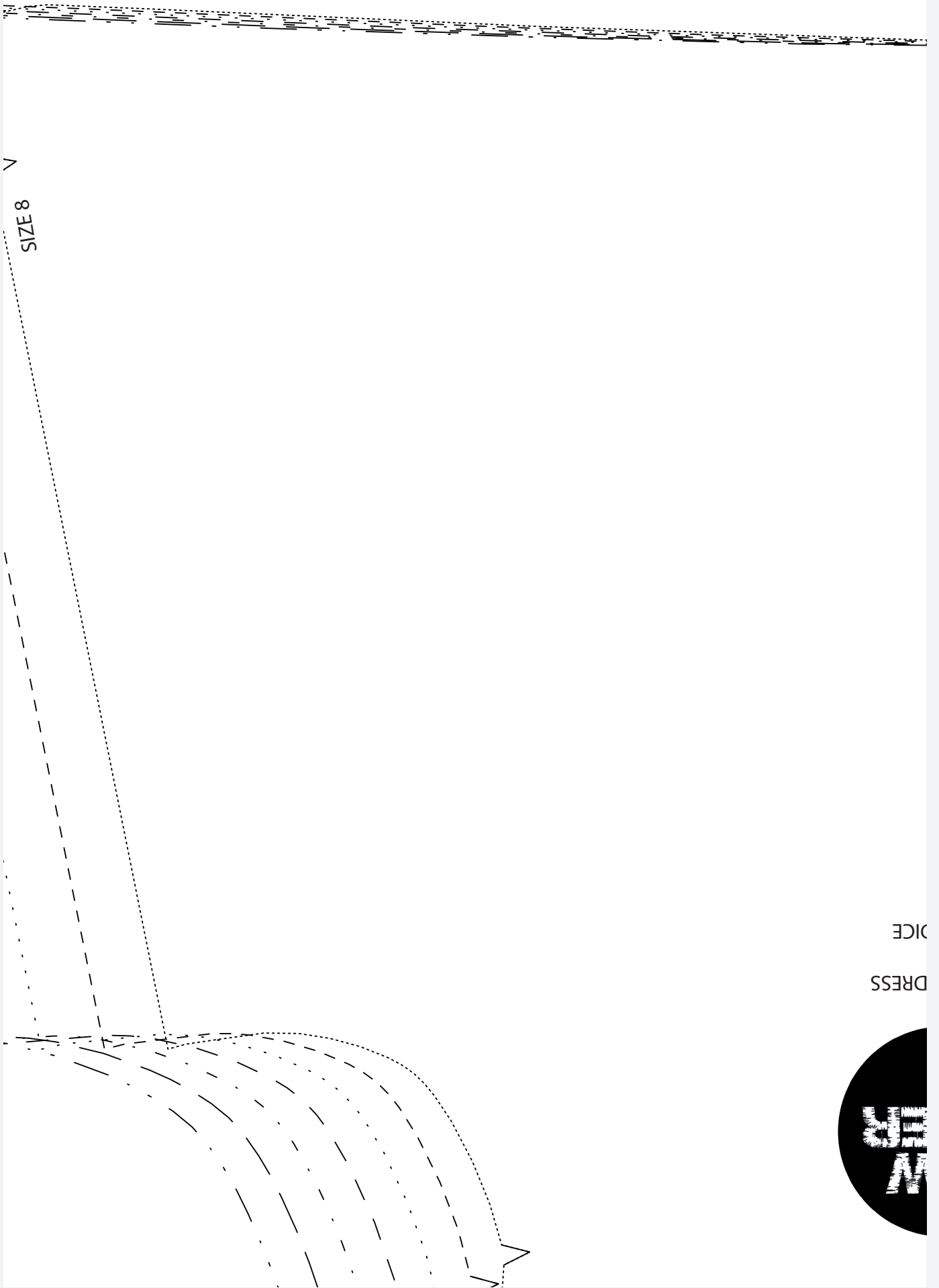

DRESS
DICE



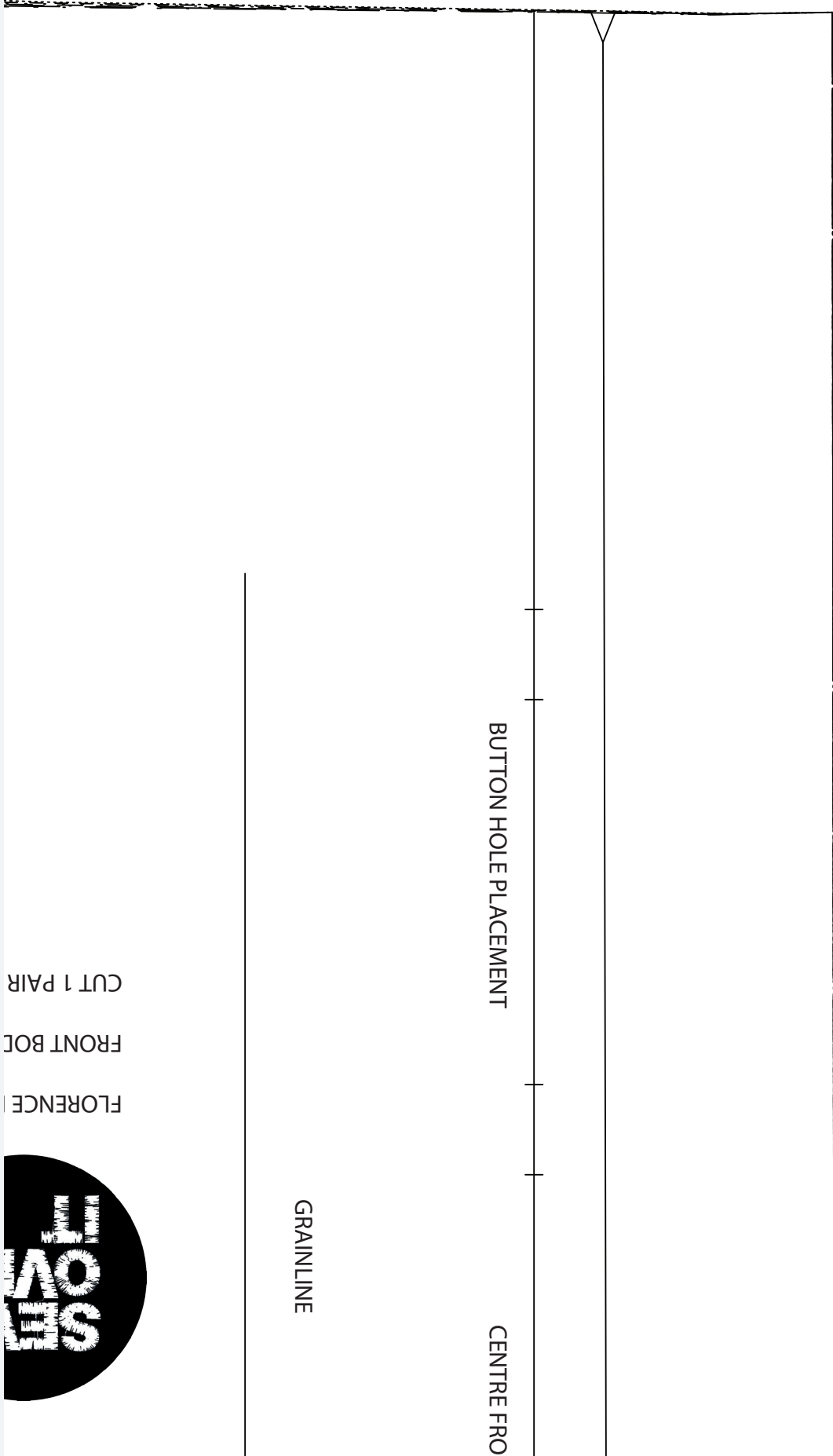

BUTTON HOLE PLACEMENT

CENTRE FRONT

GRAINLINE

FLORENCE
FRONT BODICE
CUT 1 PAIR



Wings
WITH FABRIC

ates to make part
ence Dress sew
Sew Over It.

SIZE 20
SIZE 18
SIZE 16
SIZE 14
SIZE 12
SIZE 10
SIZE 8

CENTRE BACK



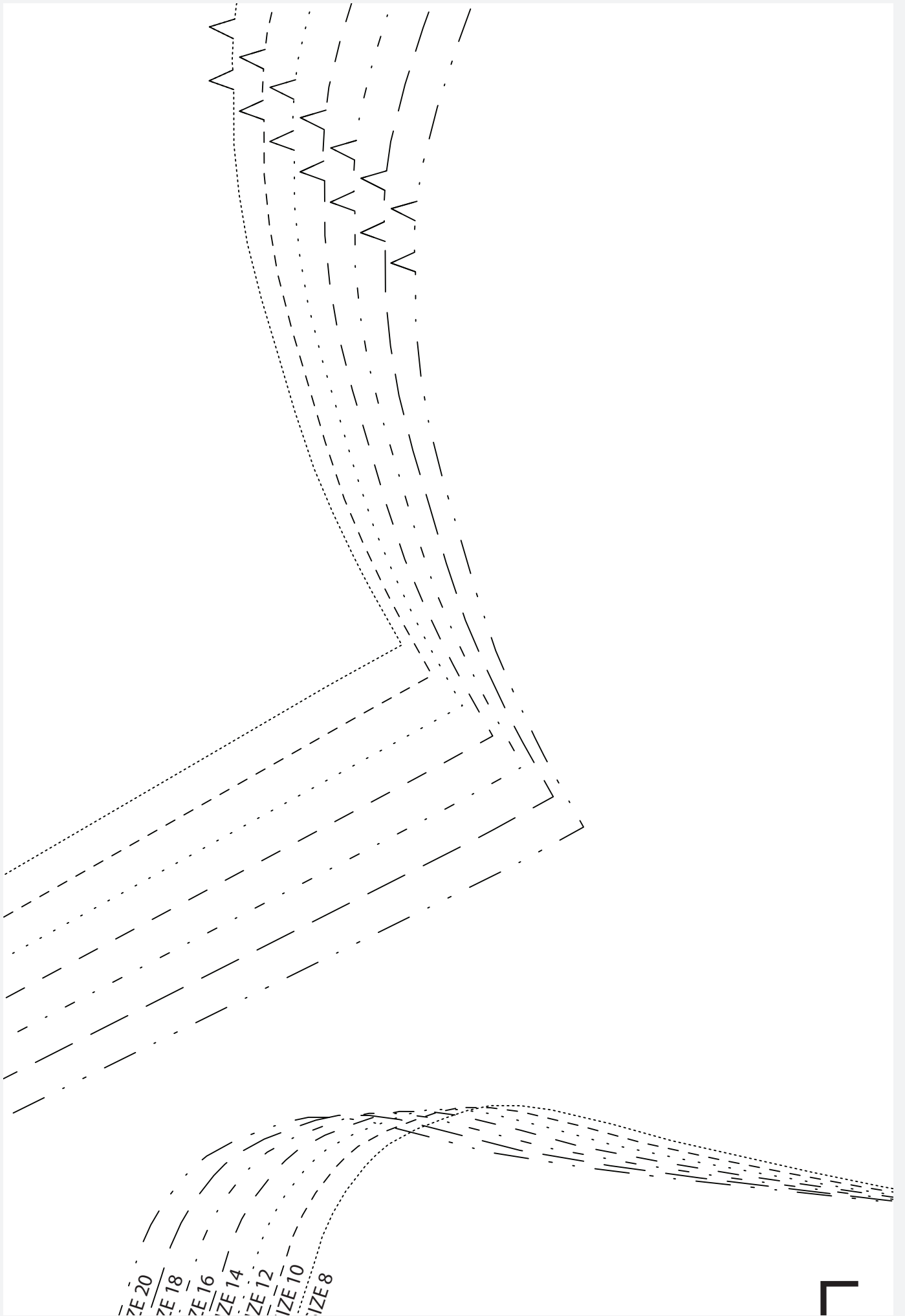



FLORENCE DRESS

F

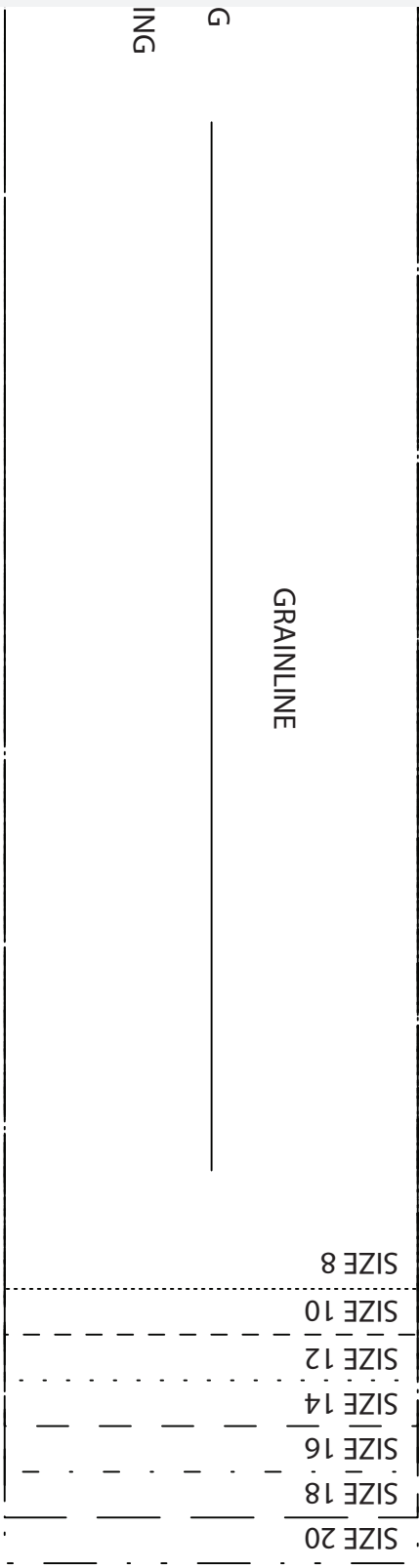

SIZE 8
 SIZE 10
 SIZE 12
 SIZE 14
 SIZE 16
 SIZE 18
 SIZE 20

GRAINLINE

ING

G

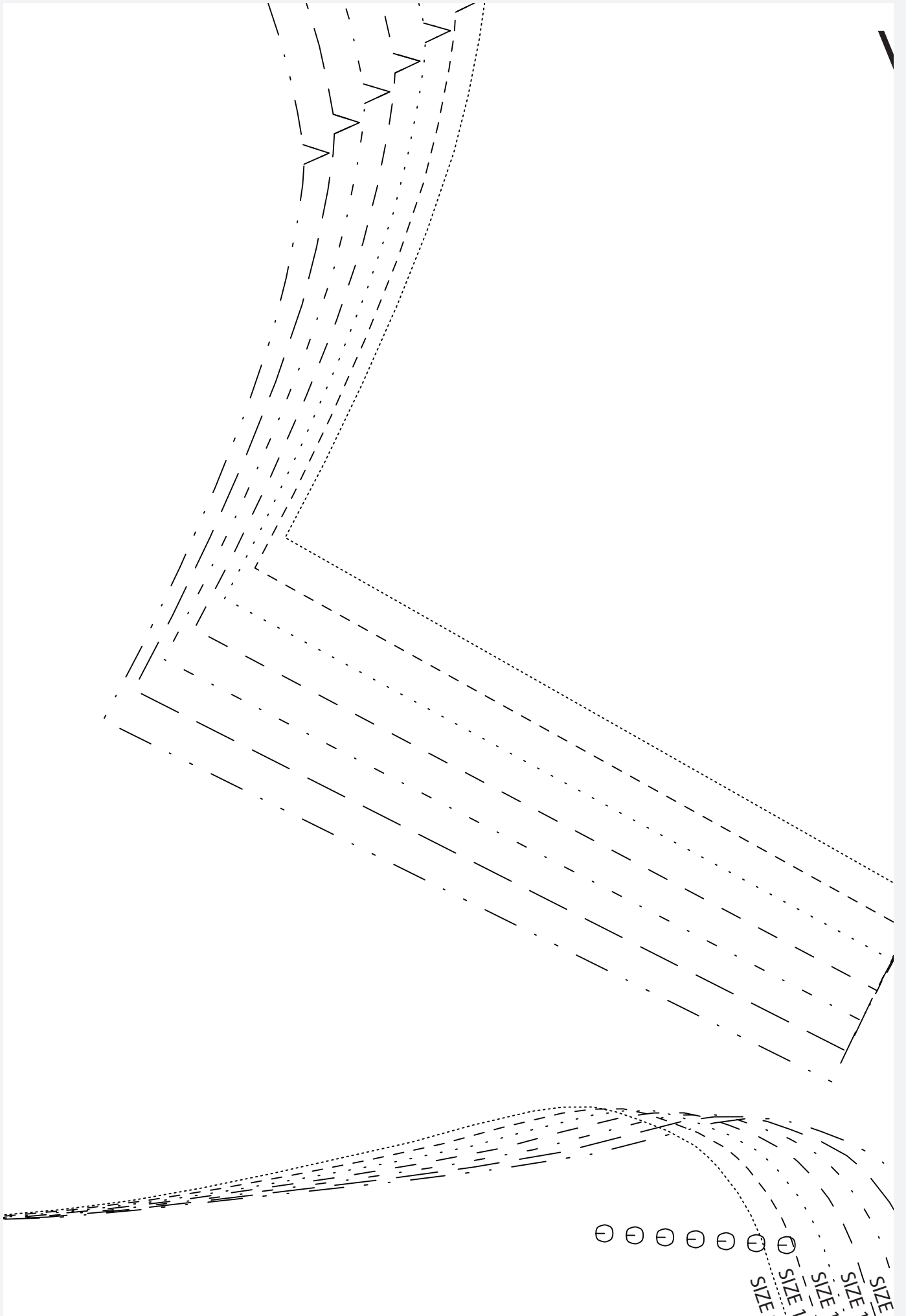

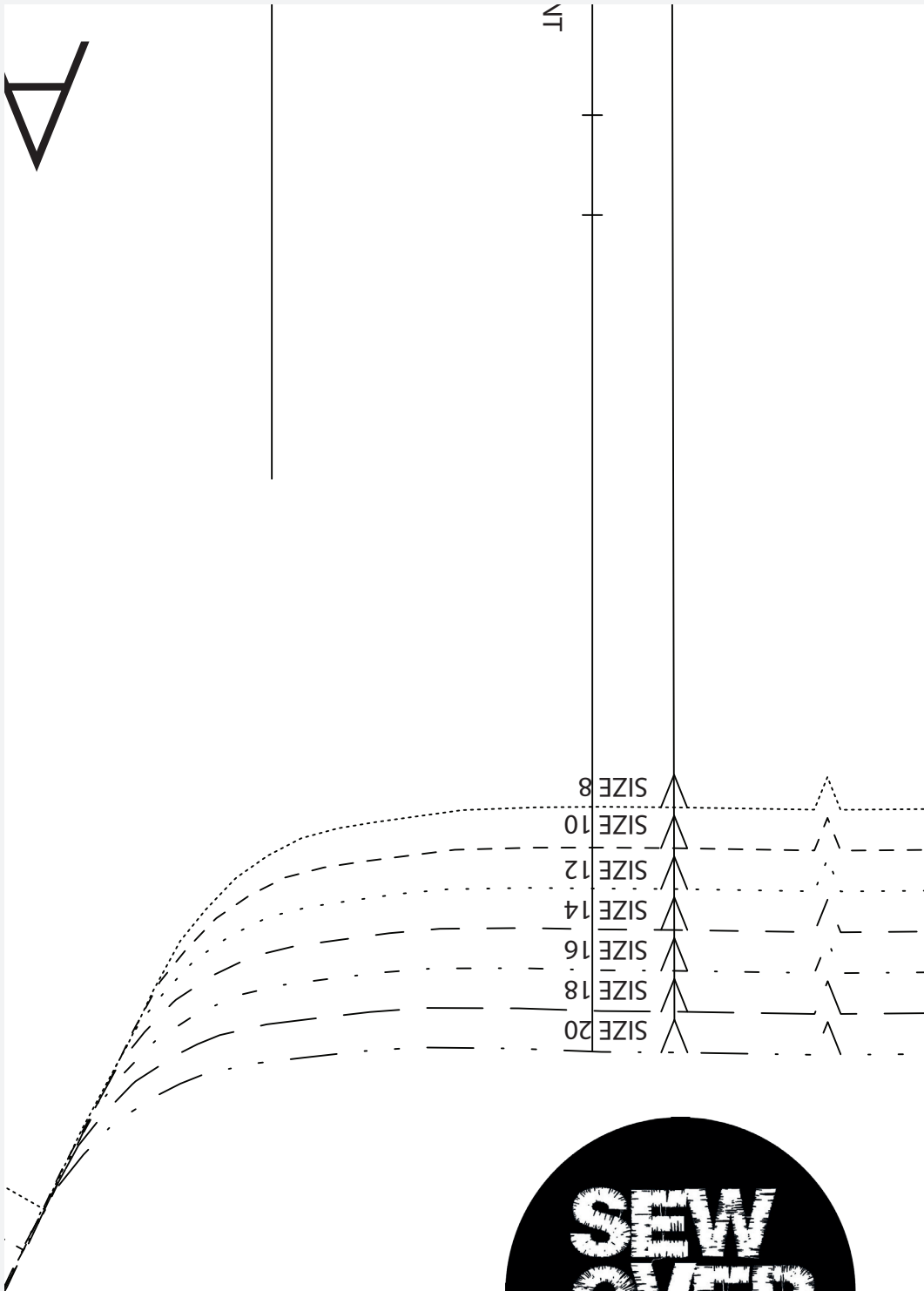

This pattern is property and copyright of Sew Over It Ltd, 2017
 This includes designs, illustrations, images, text and all other
 aspects. This pattern is for personal use and no part of it may be
 resold, reproduced or shared in any form. All rights reserved.

©2017 SEW OVER IT

Elorence Dress



Simple **SEW** FRESH IDEAS V

Use these templates
one of the Flor
along from

SIZE 20
SIZE 18
SIZE 16
SIZE 14
SIZE 12
SIZE 10
SIZE 8

20 16 12
18 14 10

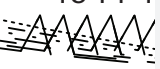



COLLAR

CUT 1 PAIR

CUT 1 INTERFACING

GRAINLINE

28
0



CENTRE BACK NOTCH

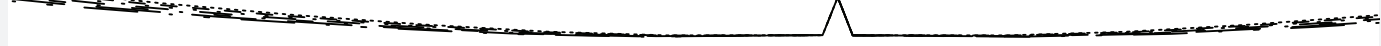

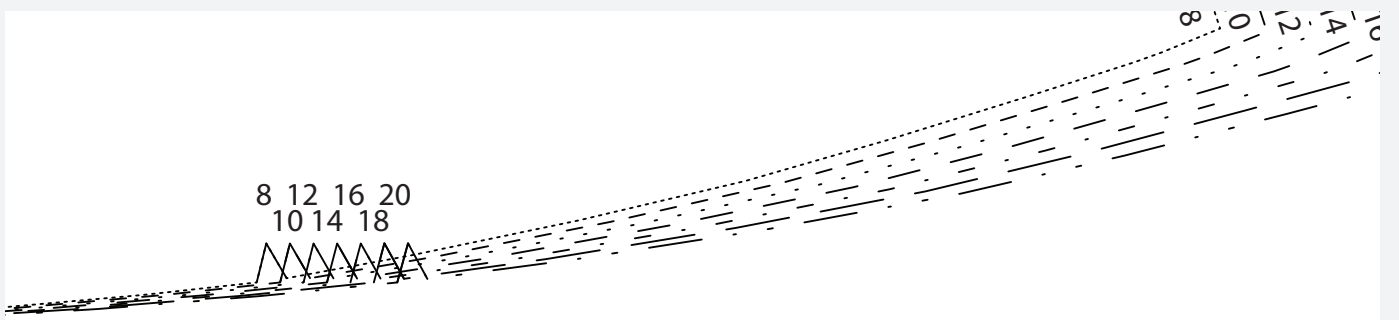

20
18
16

Womens Dress

SIZE CHART

.....	SIZE 20
————	SIZE 18
.....	SIZE 16
————	SIZE 14
.....	SIZE 12
-----	SIZE 10
.....	SIZE 8

Simply. **SEWING**

FRESH IDEAS WITH FABRIC

Use these templates to make the puppy soft toy, tote bag, key holder and lunch bag.

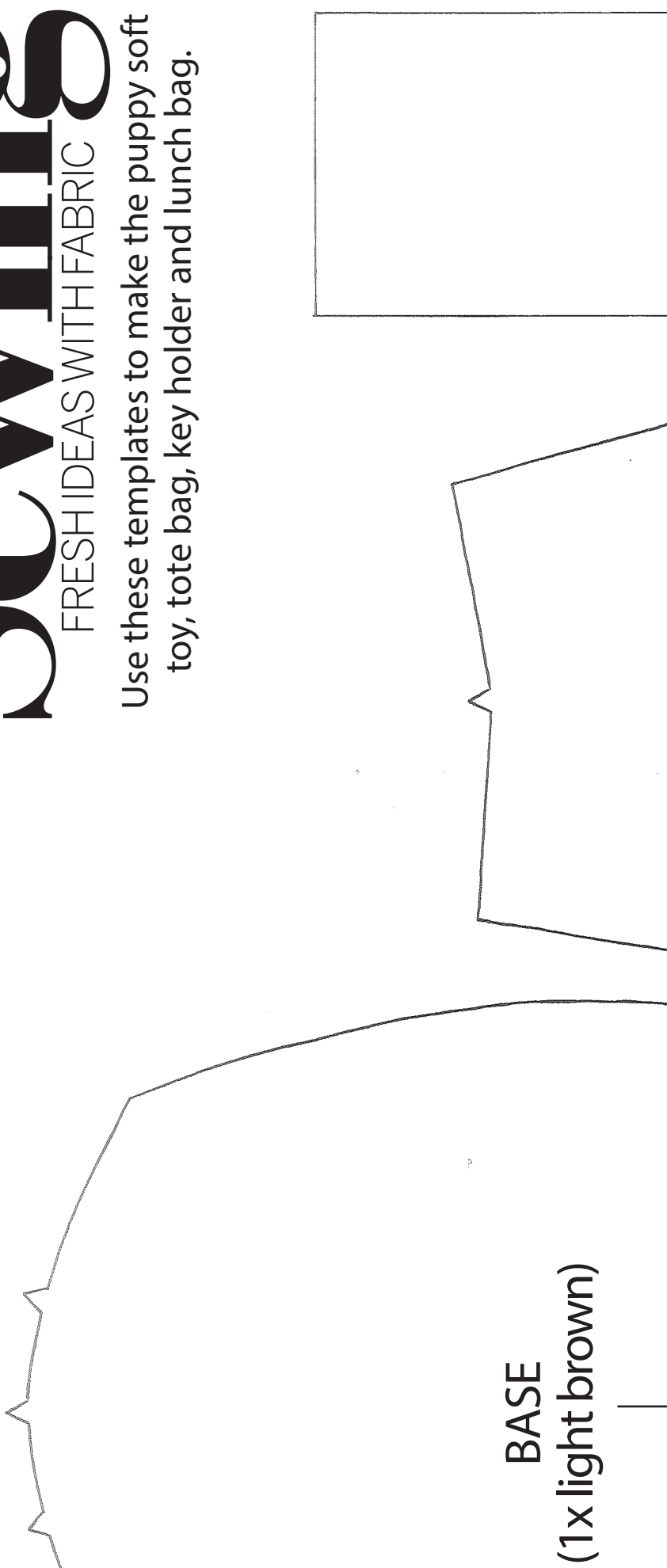

BASE
(1x light brown)

COLLAR
(1x cotton
print)

print
→

LEG
(2x light brown
2x brown)



TOP EAR
(2x brown)

TAIL
brown)



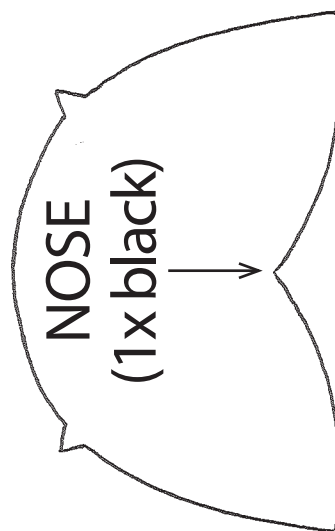
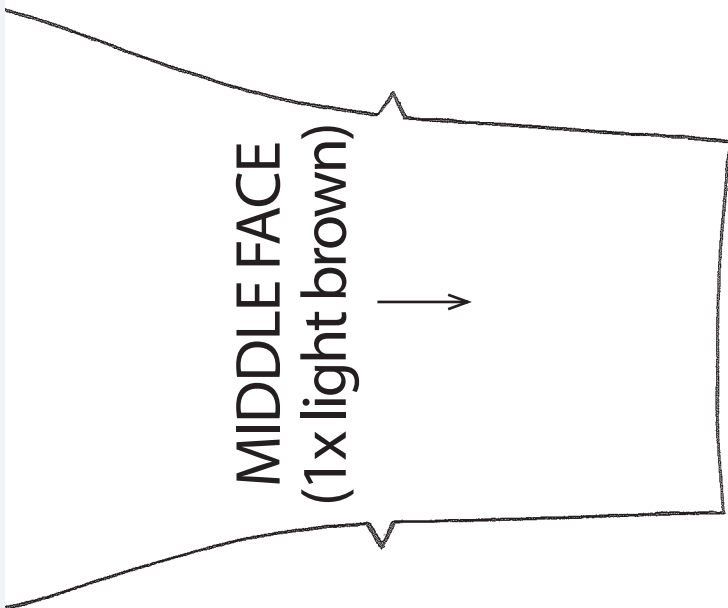
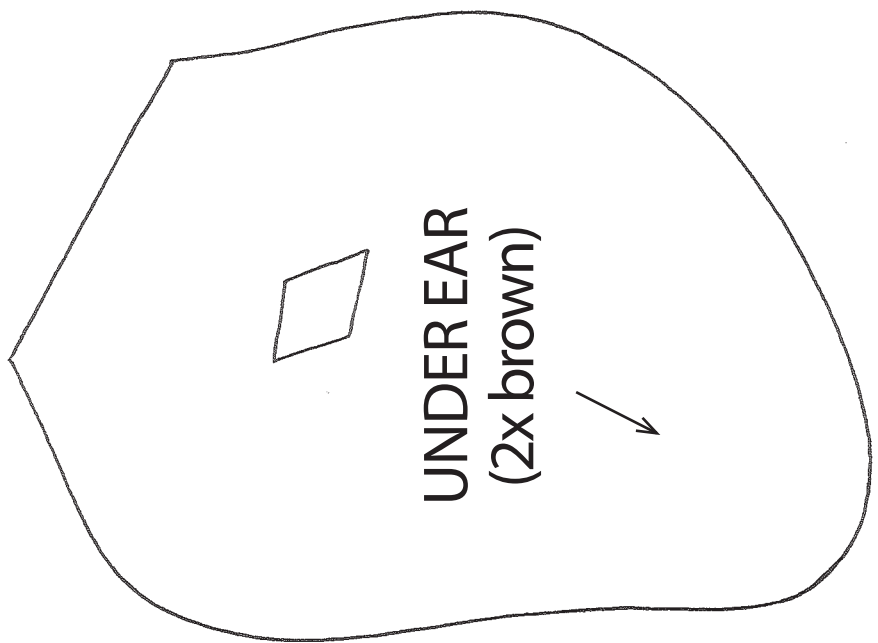
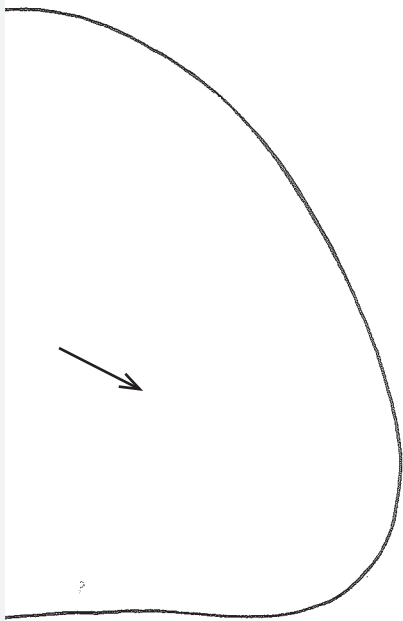

LUNCH BAG
FLAP

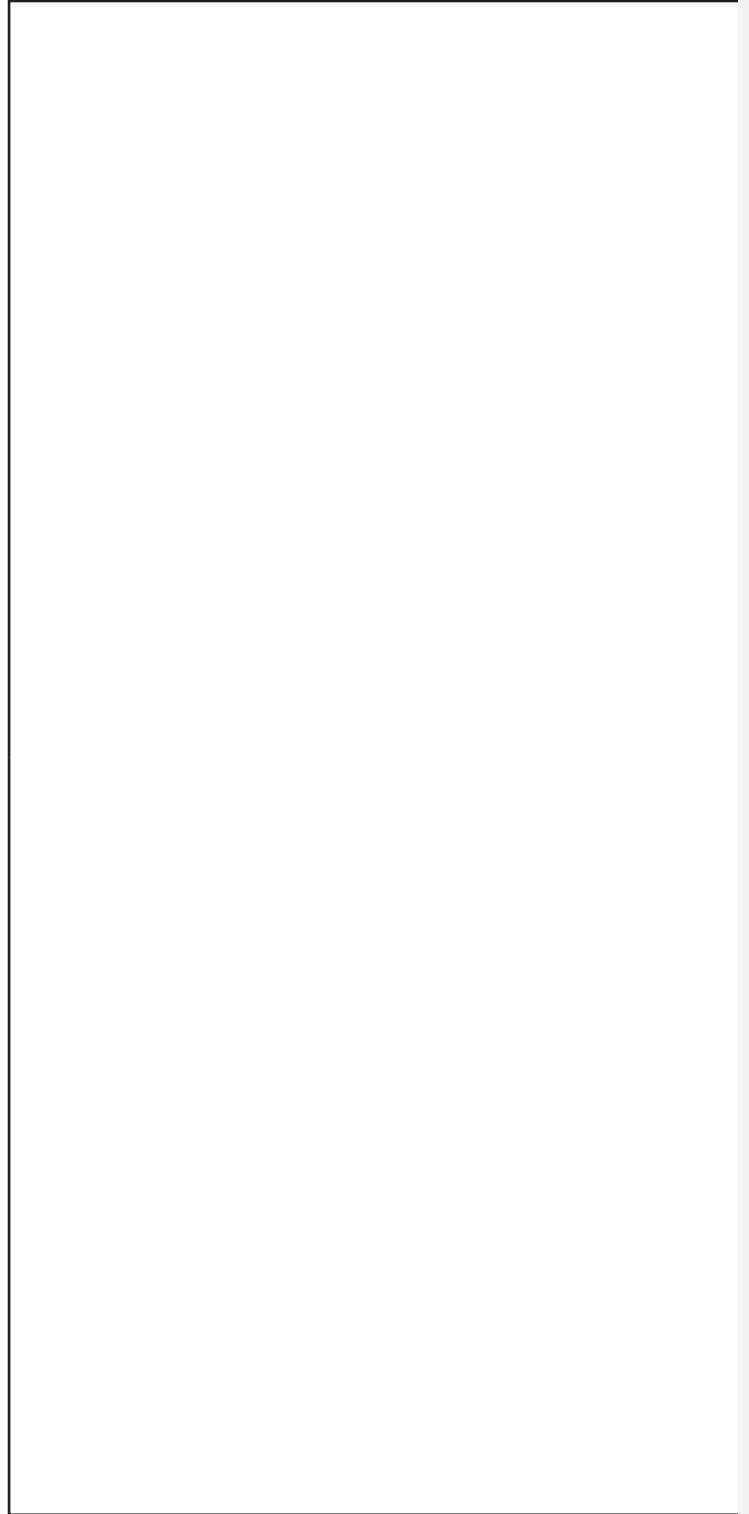

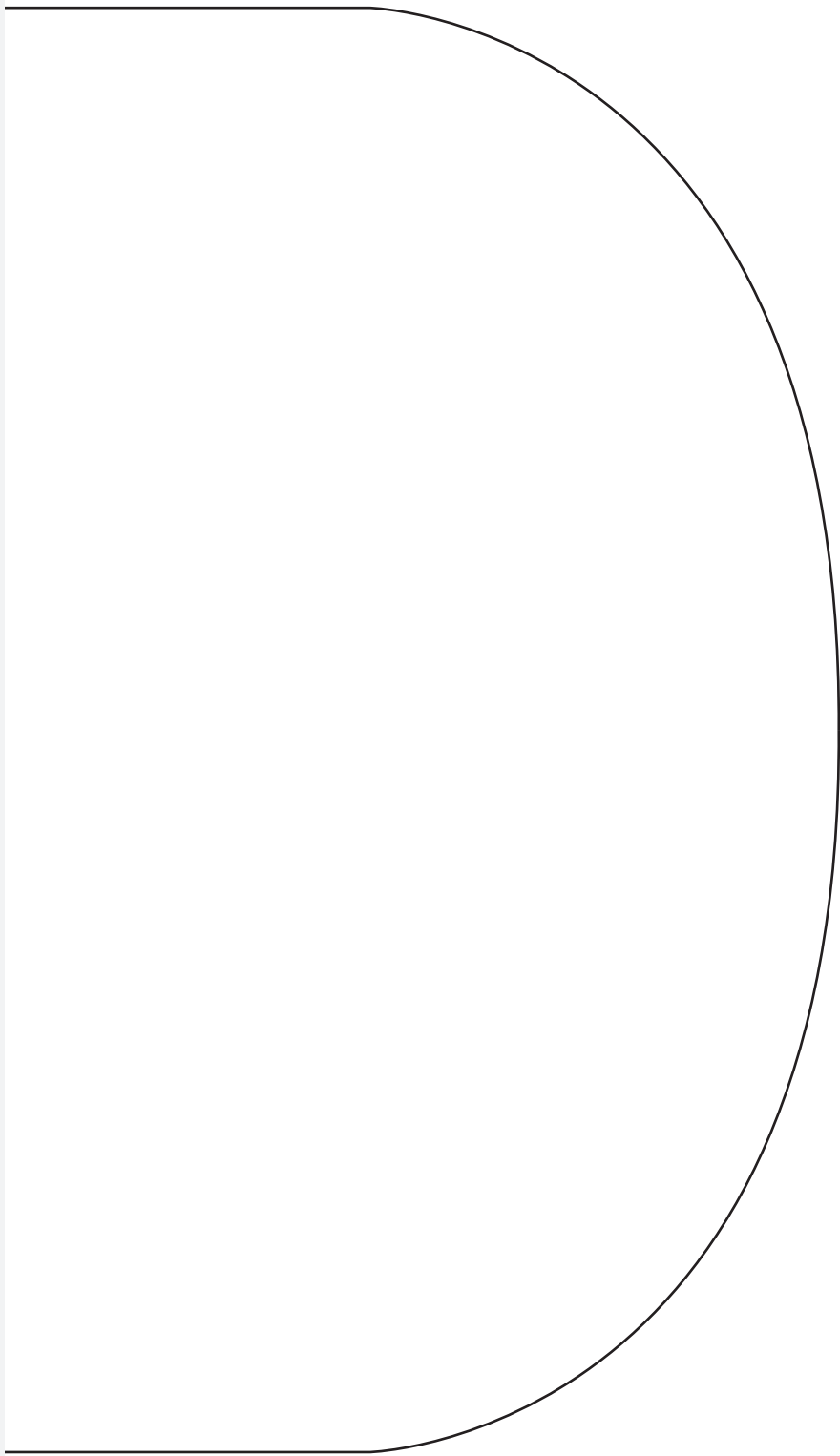

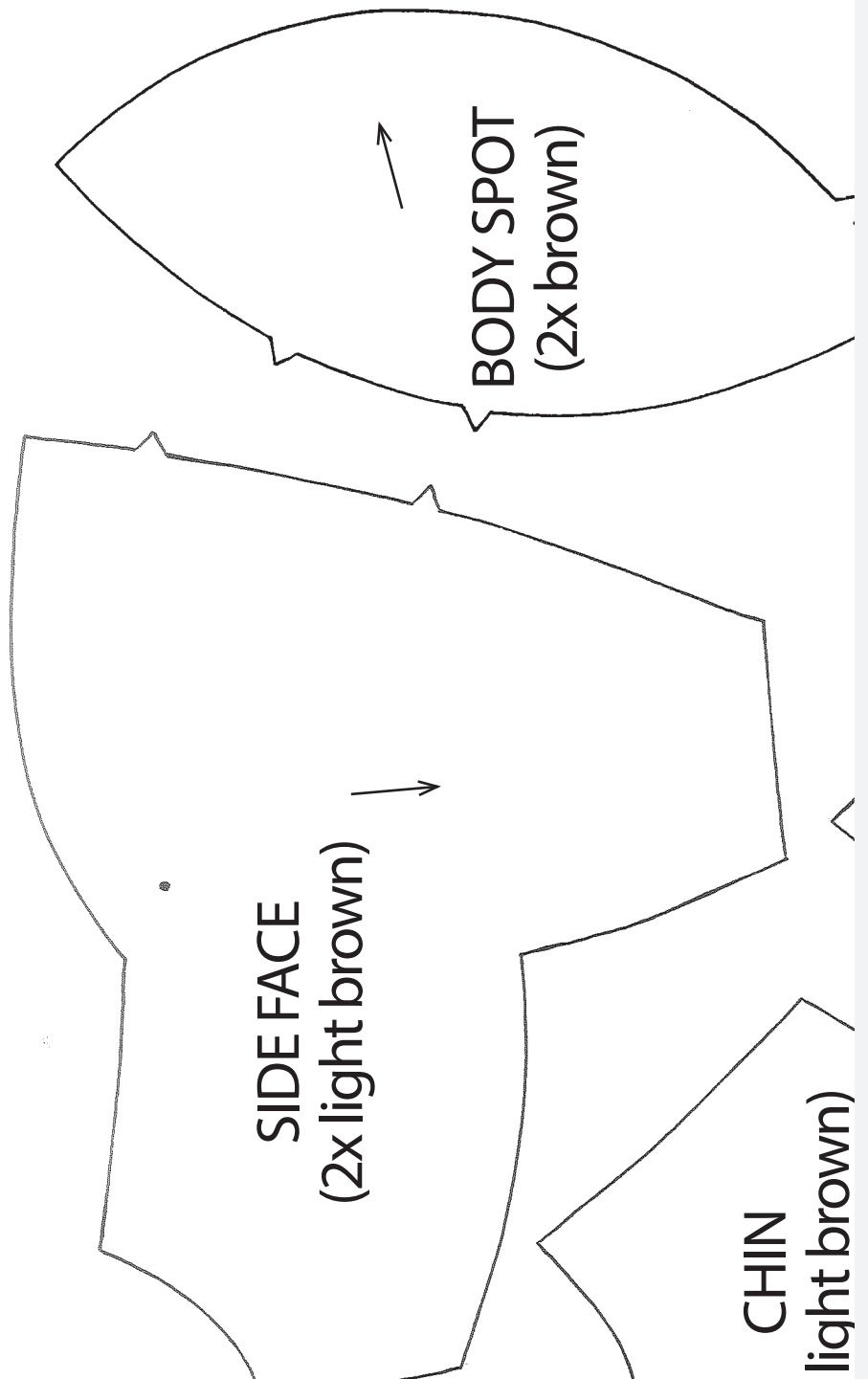

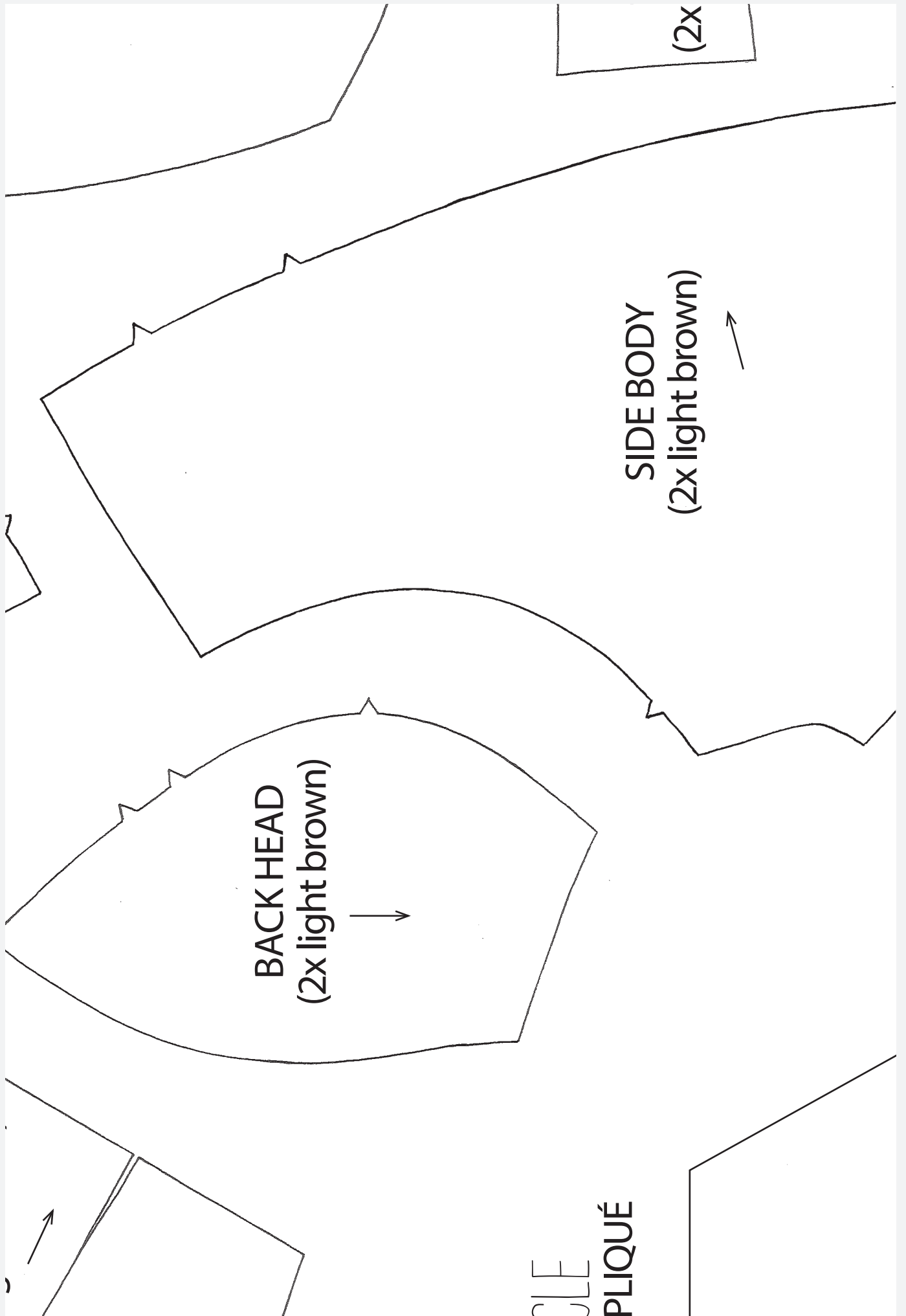

LLWAY
PLIQUÉ

BOOKS

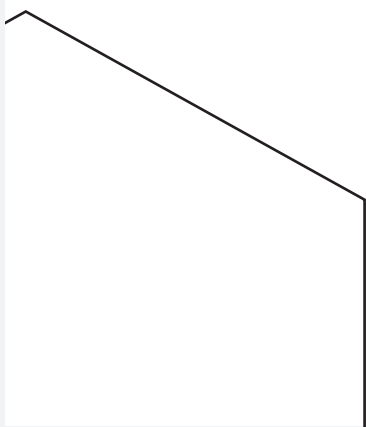
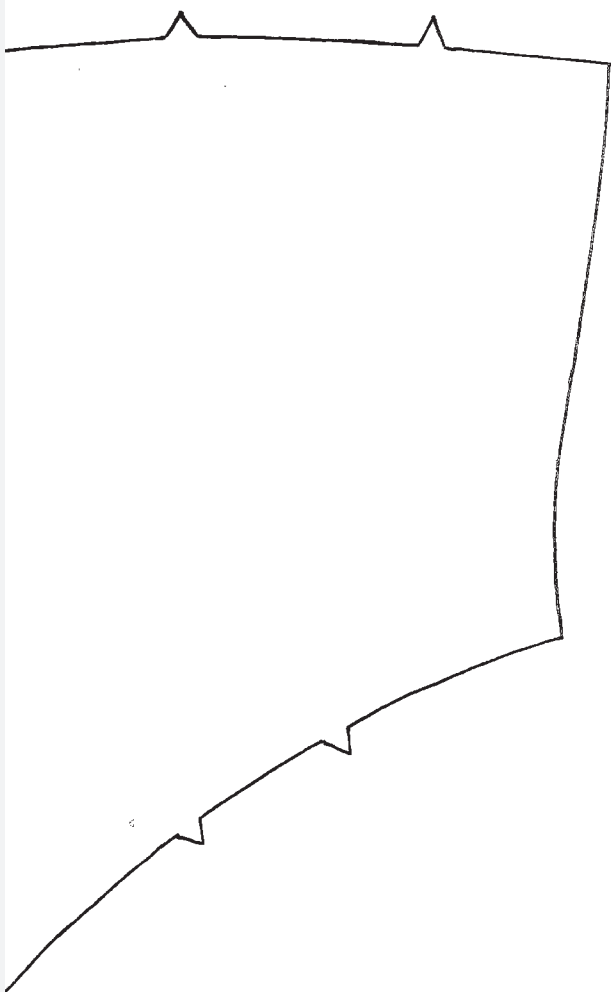

Handwritten cursive letters 'b' and 't' in black ink, repeated twice. The letters are thick and stylized, with a small loop at the top of the 'b' and a small loop at the top of the 't'. The letters are arranged in two rows, with the first row containing two 'b's and the second row containing two 't's.

APPLIQUÉ



How to Sew

acts from *Simply Sewing*. The copyright for these templates belongs to the designer of the projects for you to enjoy, so please don't re-sell or distribute their work without permission. e templates or instructions available to others through your website or a third party website, our permission. Copyright law protects creative work and unauthorised copying is illegal. nd more templates and ideas at www.simplysewingmag.com



PUPPY TOY

(1x)

DENIM UPCYCLING
HEXAGON AP

MODERN HA
TOTE BAG AP



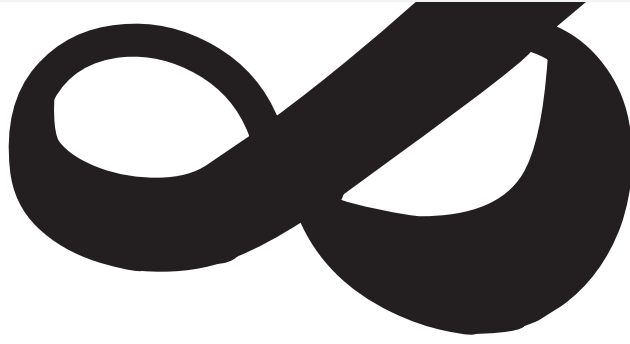

KEY HOLDER





Thank you for making these proje
project. They work hard to create
Please do not make any part of th
or copy it multiple times without
We really appreciate your help. Fi