

Housut

Koot: XS(S)M(L)XL

Housun lahkeen sisäpituus on noin 73 cm ja lahkeensuun ympäryys 30 cm.

Tarvikkeet: Collegeneulosta tai tukevaa trikoota 1,25 m, leveys 150 cm. 5 cm:n levyistä kuminauhaa vyötärölle. Ompelukoneeseen kaksoisneula.

Valmistelut: Takakappaleen kaava on kaava-arkilla kahdessa osassa. Yhdistä osat.

Leikkaaminen: Ks. leikkuusuunnitelmaa ja lisää leikatessasi 1 cm:n saumanvarat ja lahkeensuuhun 2 cm:n päärmeenvara. Leikkaa lisäksi vyötärökaitale 12 x 75(80)84(91)97 cm (sis. sv:t).

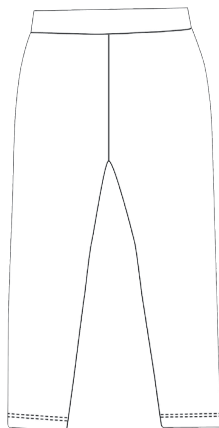
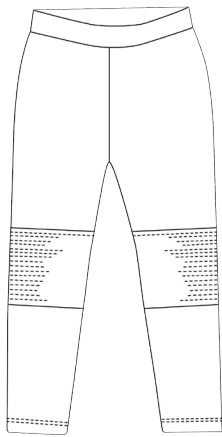

- 7 etukpl:n yläosa
- 8 etukpl:n polvipaikka
- 9 etukpl:n alaosa
- 10+10a takakpl

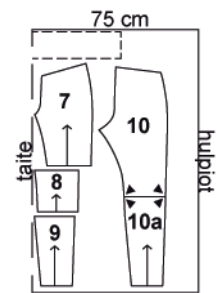

Ompeleminen:

Ompele saumat saumurilla tai ompelukoneen joustavalla huolittelevalla ompeleella.

1. Tikkaa etukappaleiden polvipaikat vaakasuuntaisesti noin 7 mm:n välein.
2. Ompele etukappaleiden osat yhteen.
3. Ompele sivusaumat ja lahkeiden sisäsaumat.
4. Ompele haarasauma.

5. Ompele vyötärökaitaleen lyhyet päät yhteen. Mittaa kuminauhasta sopivan pituinen vyötärökuminauha. Ompele kuminauha renkaaksi. Taita vyötärökaitale kaksin kerroin nurjat vastakkain ja aseta kuminauharengas kaitaleen väliin. Harsi avoimet reunat yhteen ja ompele kaitale avoimesta reunastaan vyötärölle samalla kuminauhaa venyttäen.
6. Ompele lahkeensuun päärmeet kaksoisneulalla.

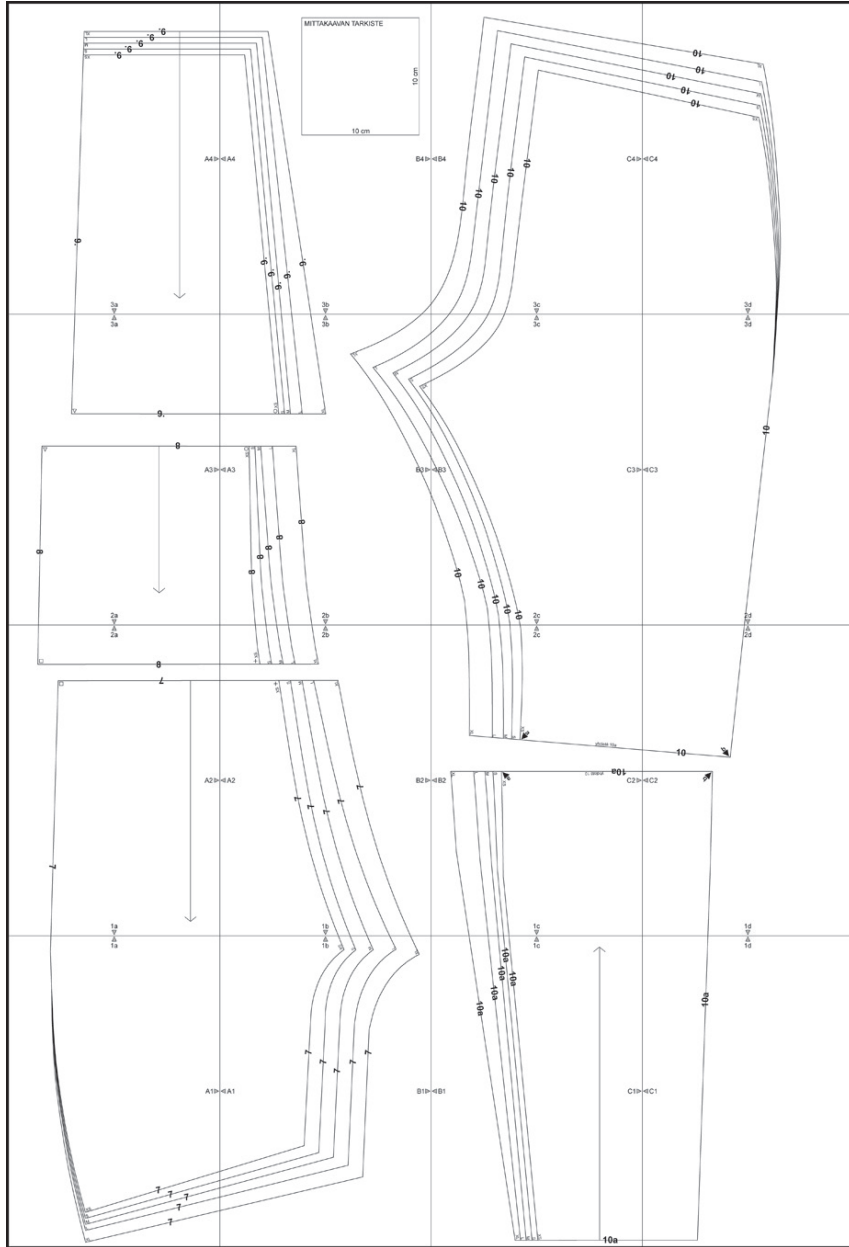

▲
1a



A1▶

XS
S
M
L
XL

7
7
7
7
7



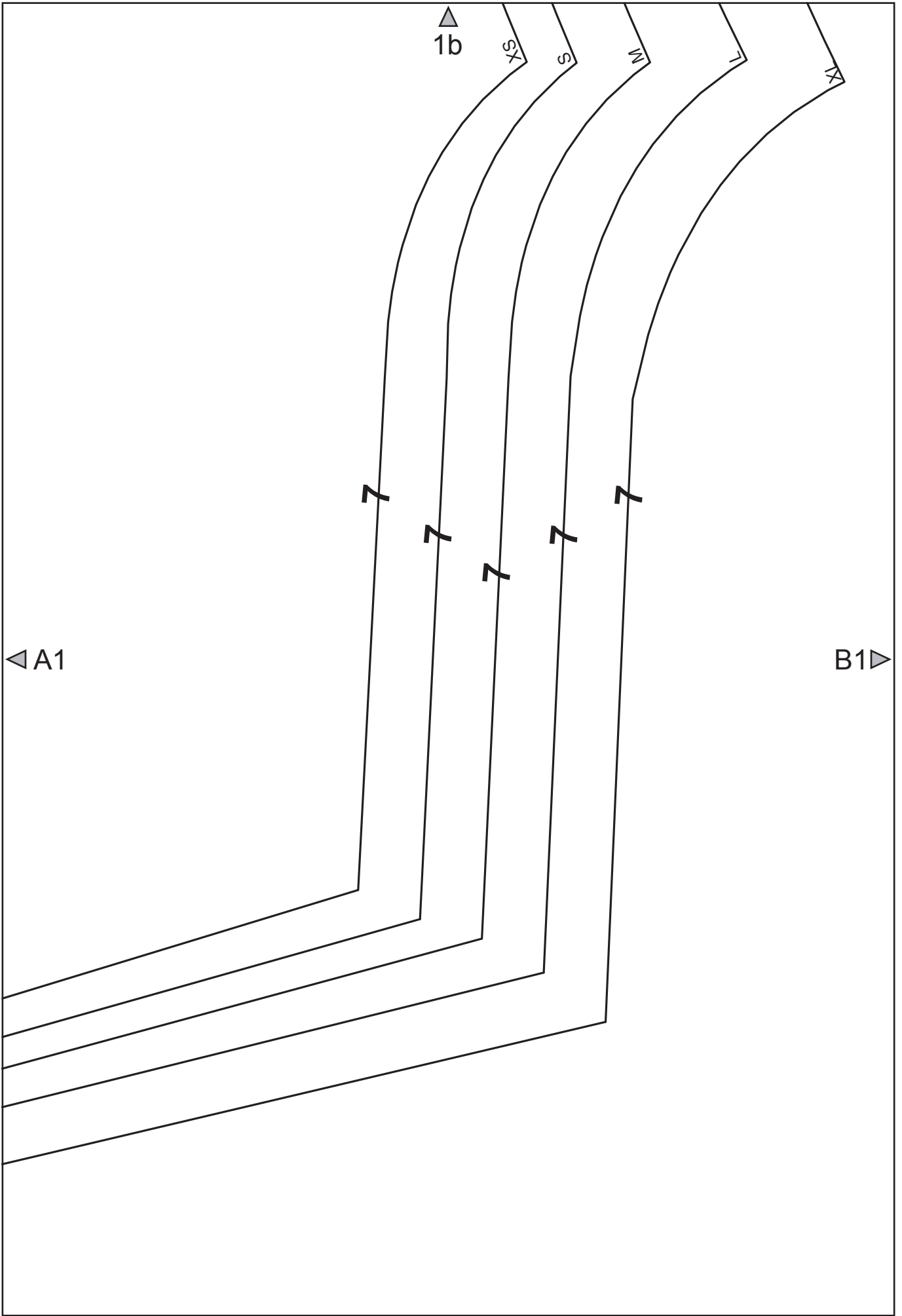

✂ A1

B1 ▶

1b ▲

X

S

M

L

A

7

7

7

7

7

✂

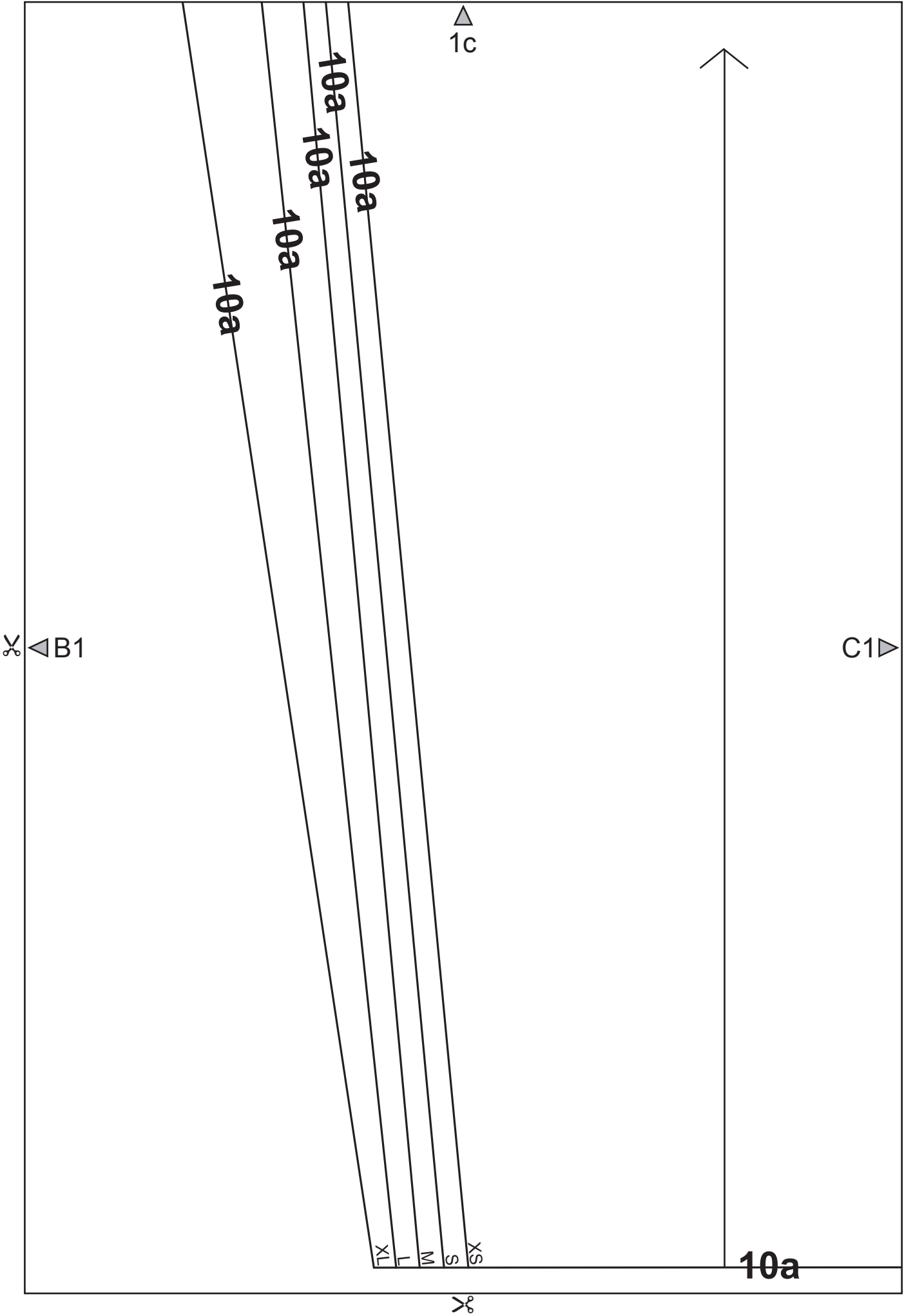

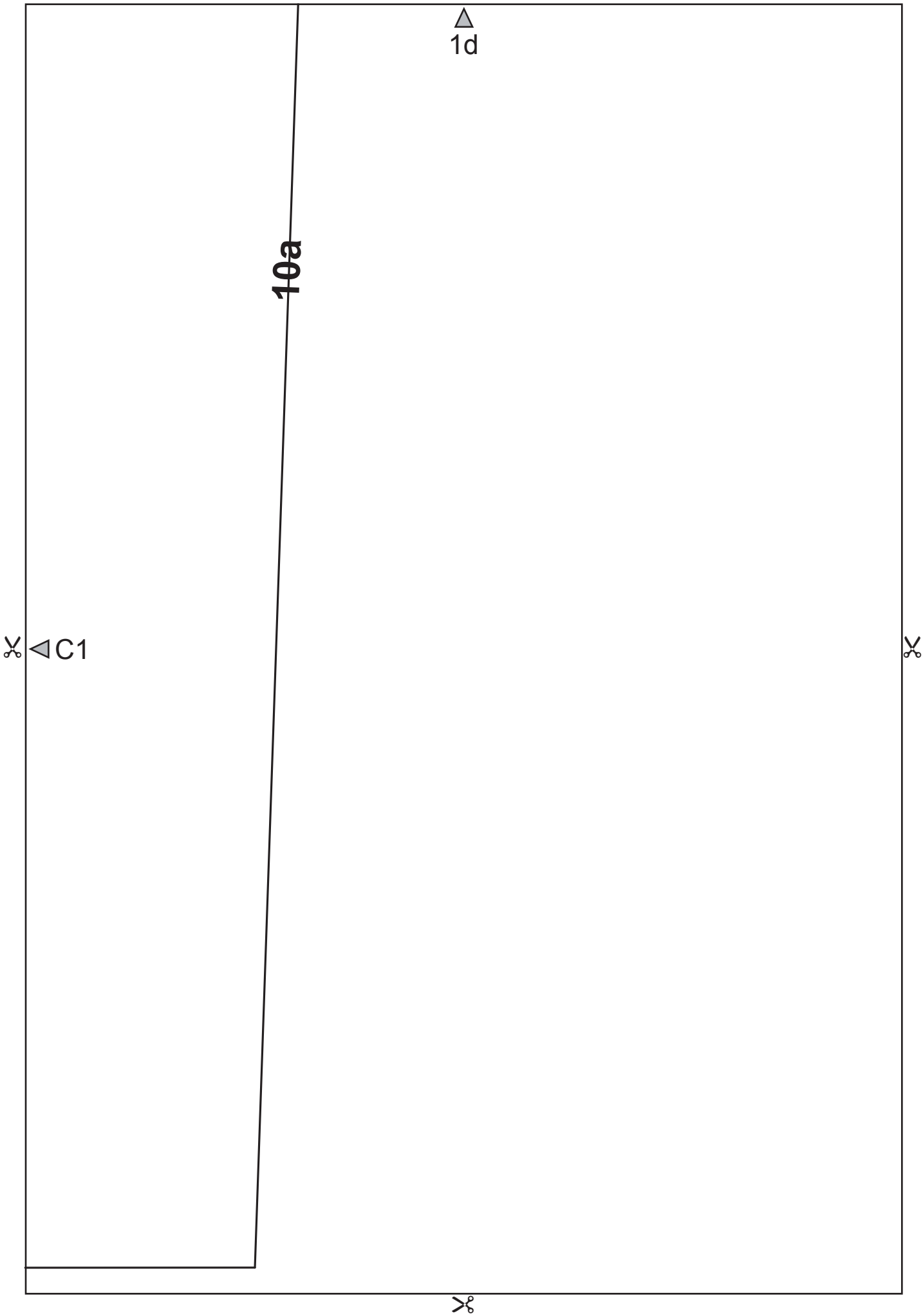

△
2a



8

2



2



A2 ▷

▽
1a
✂



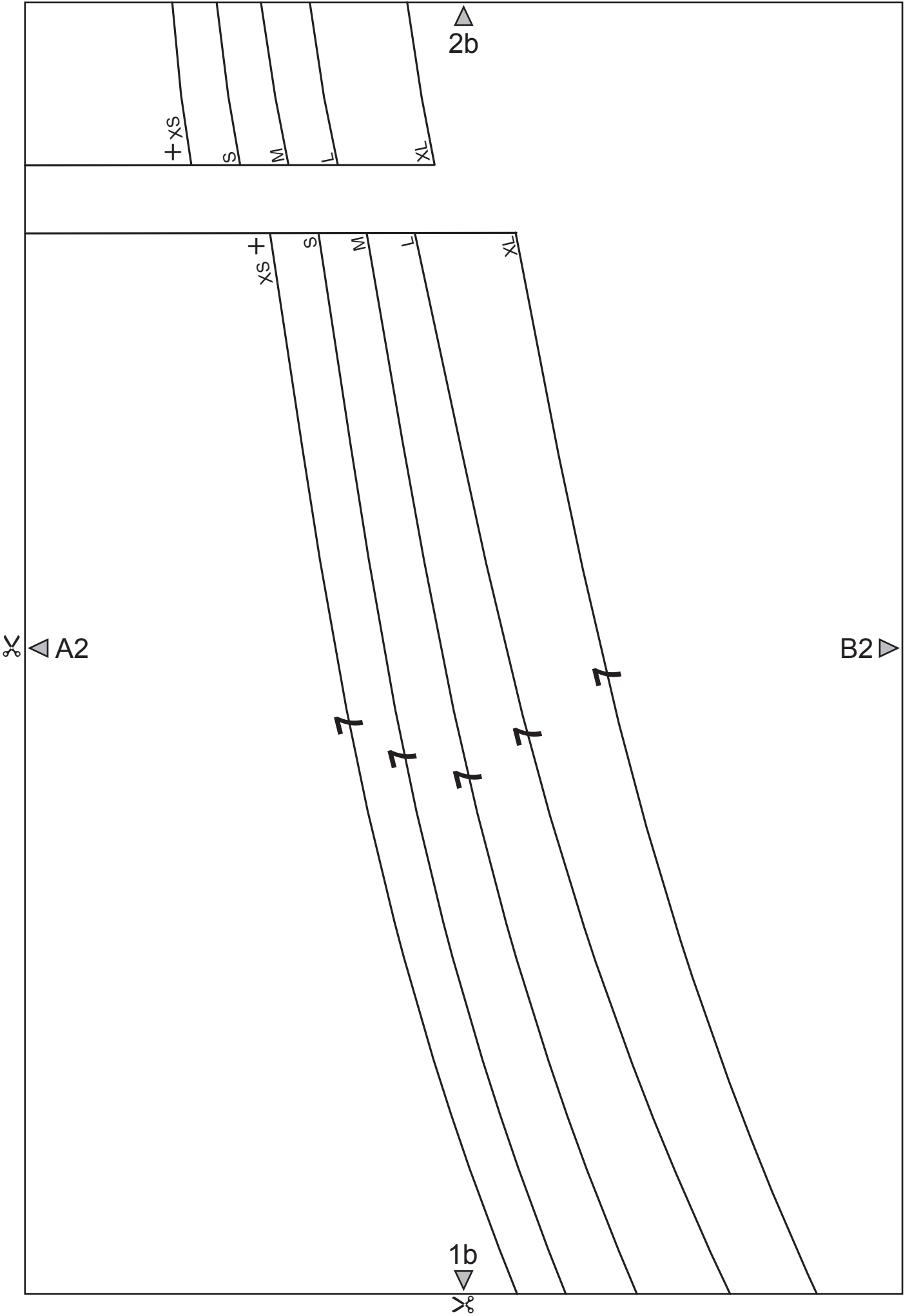

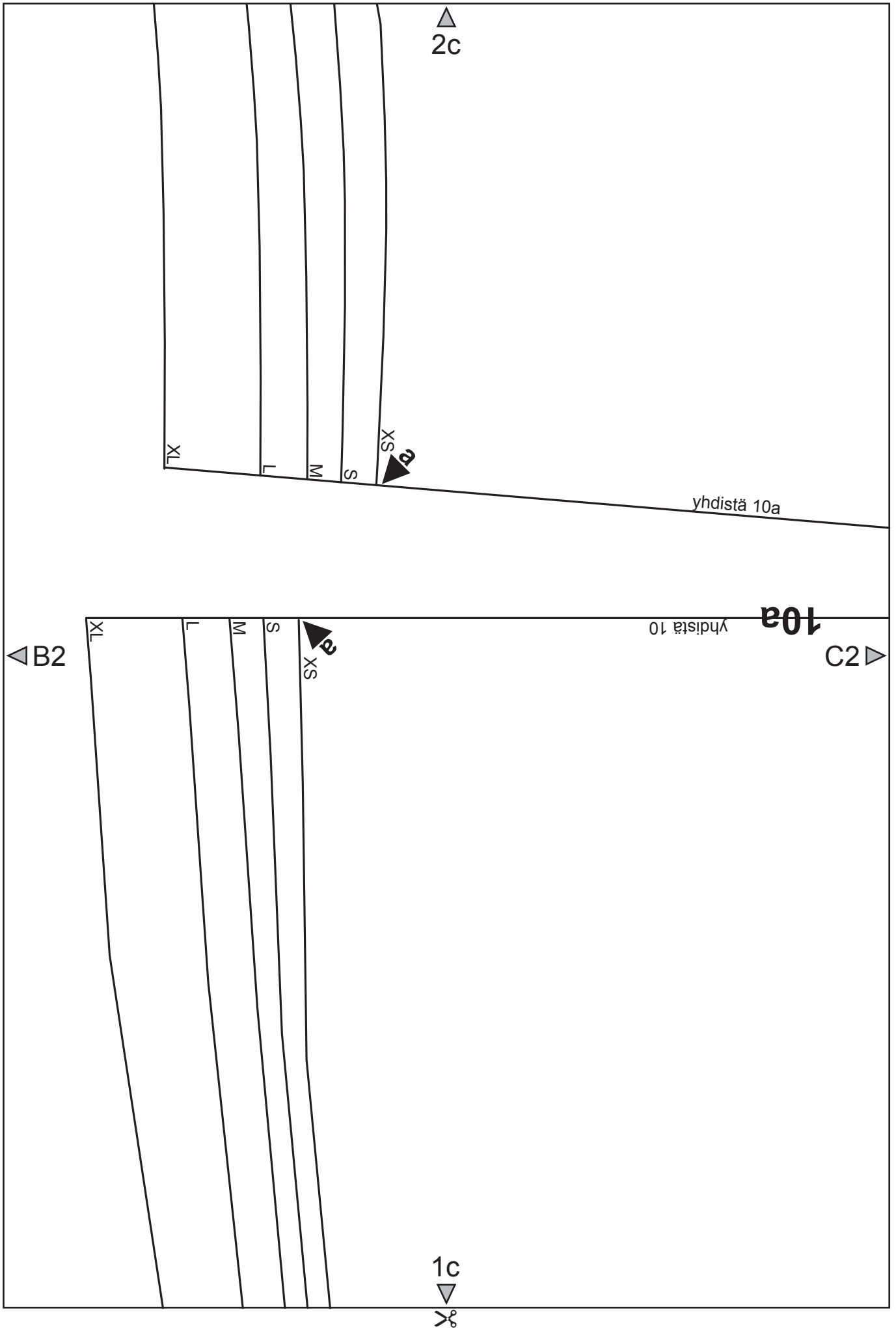

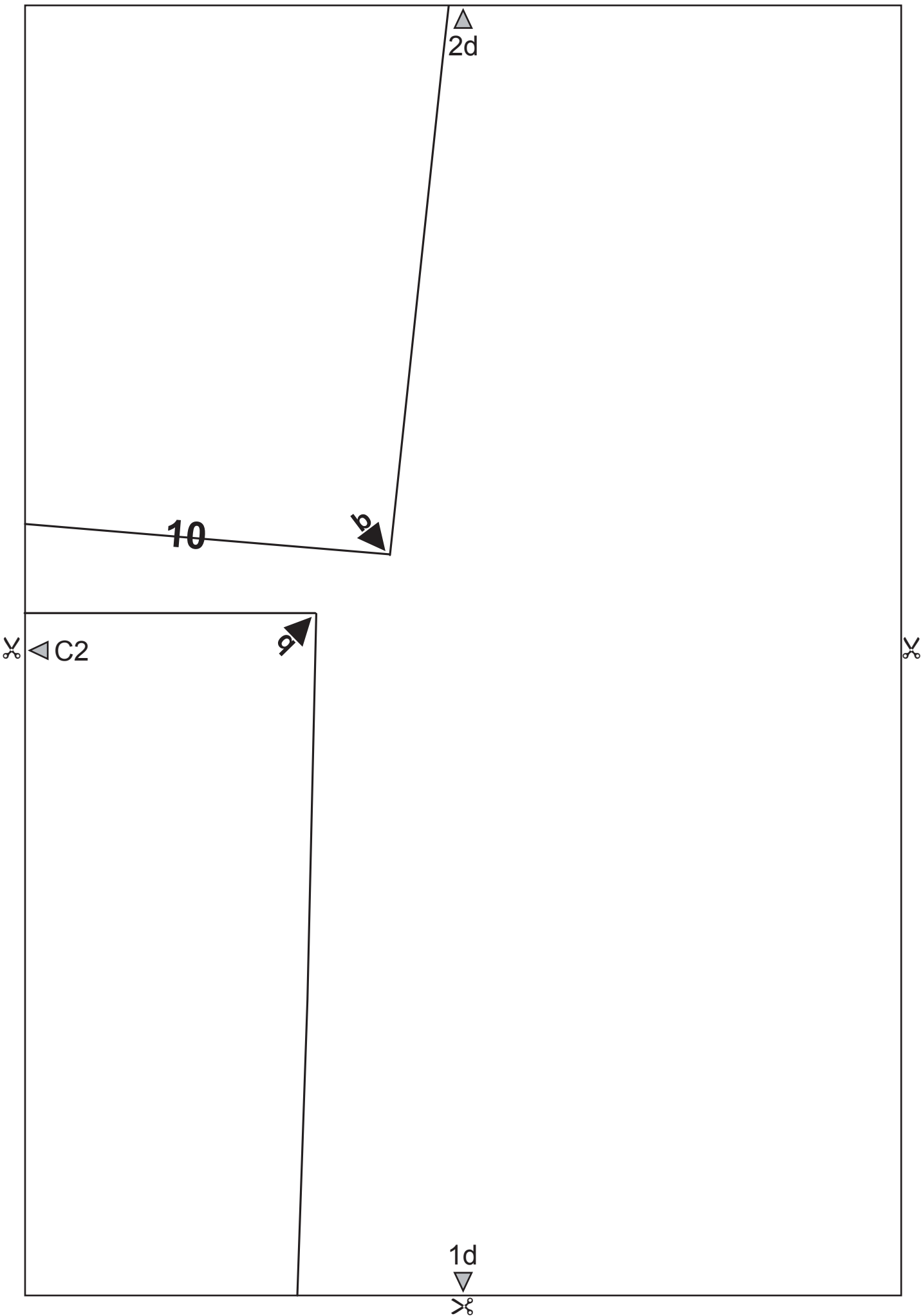

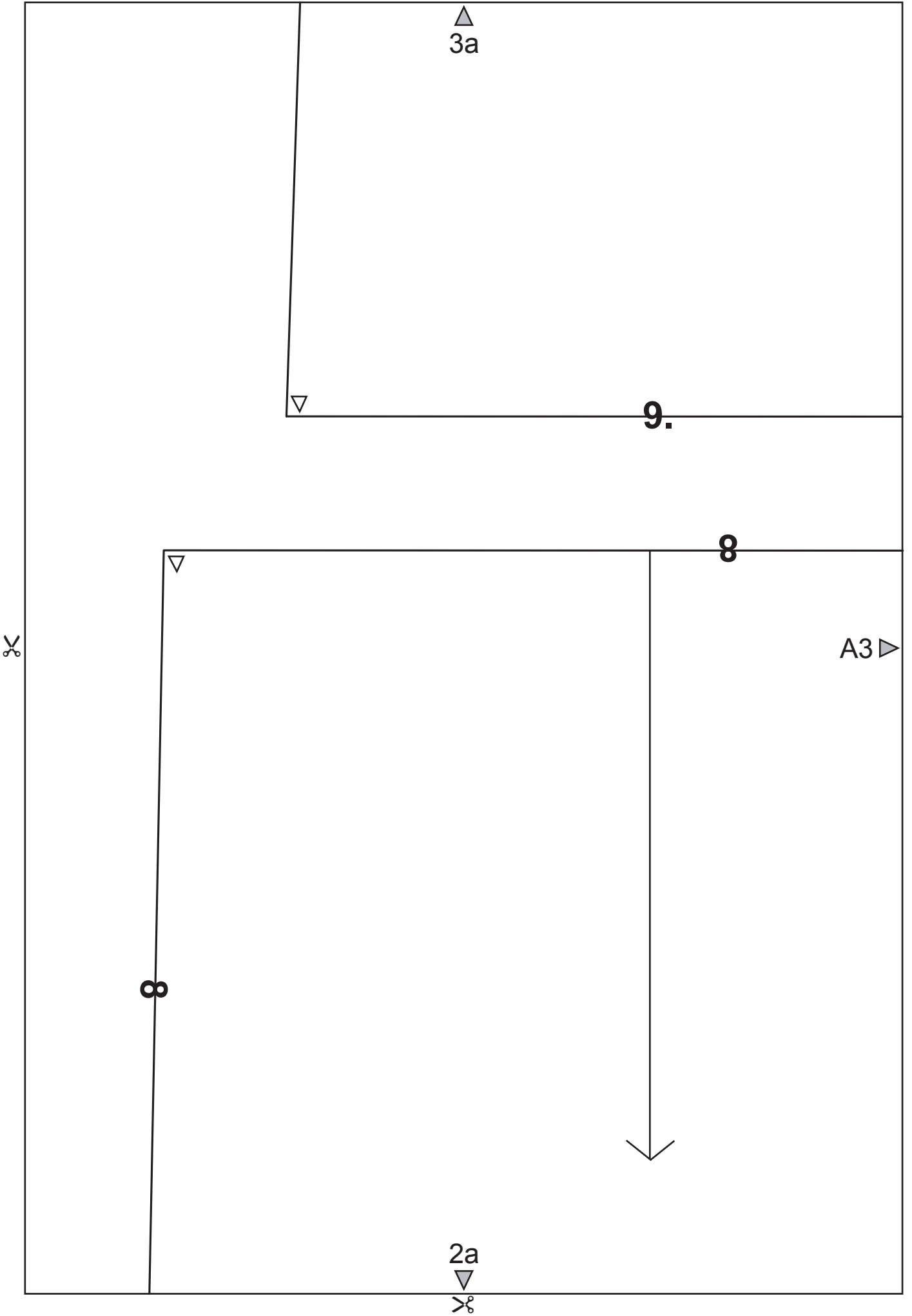

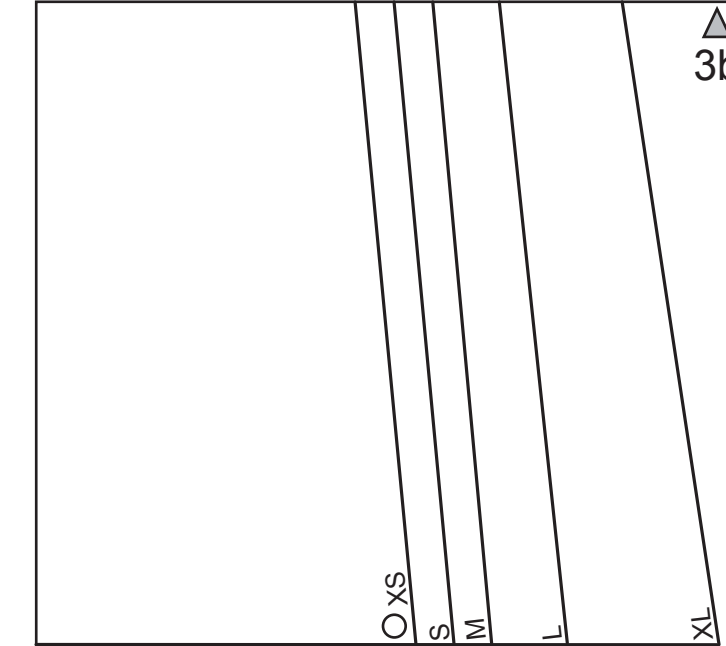
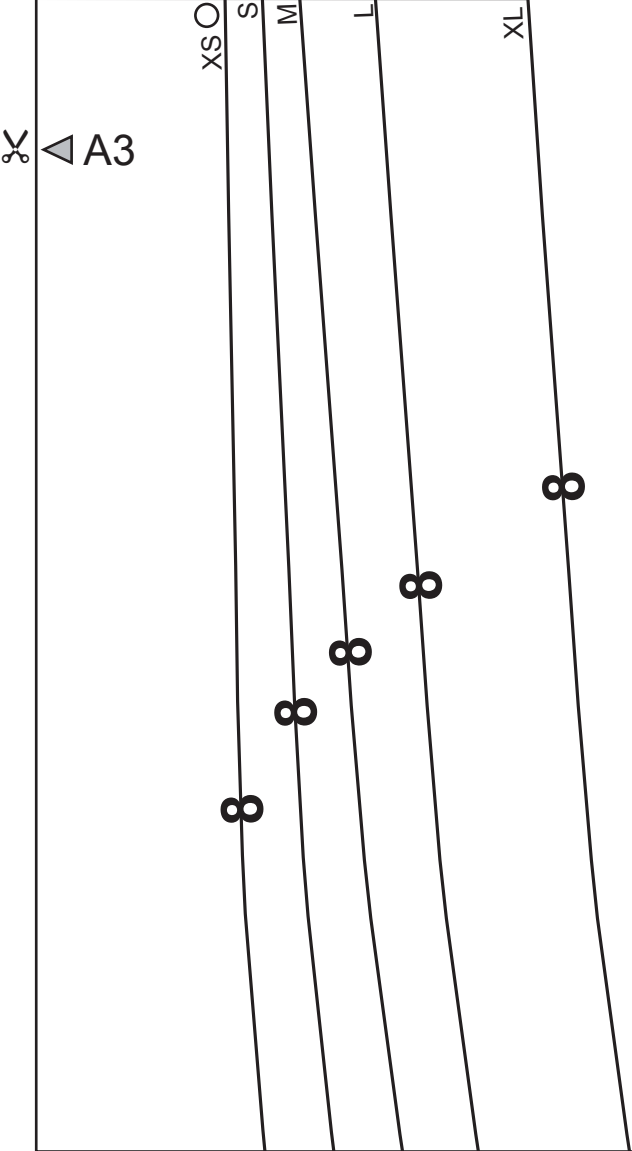

A3

B3

2b

3b

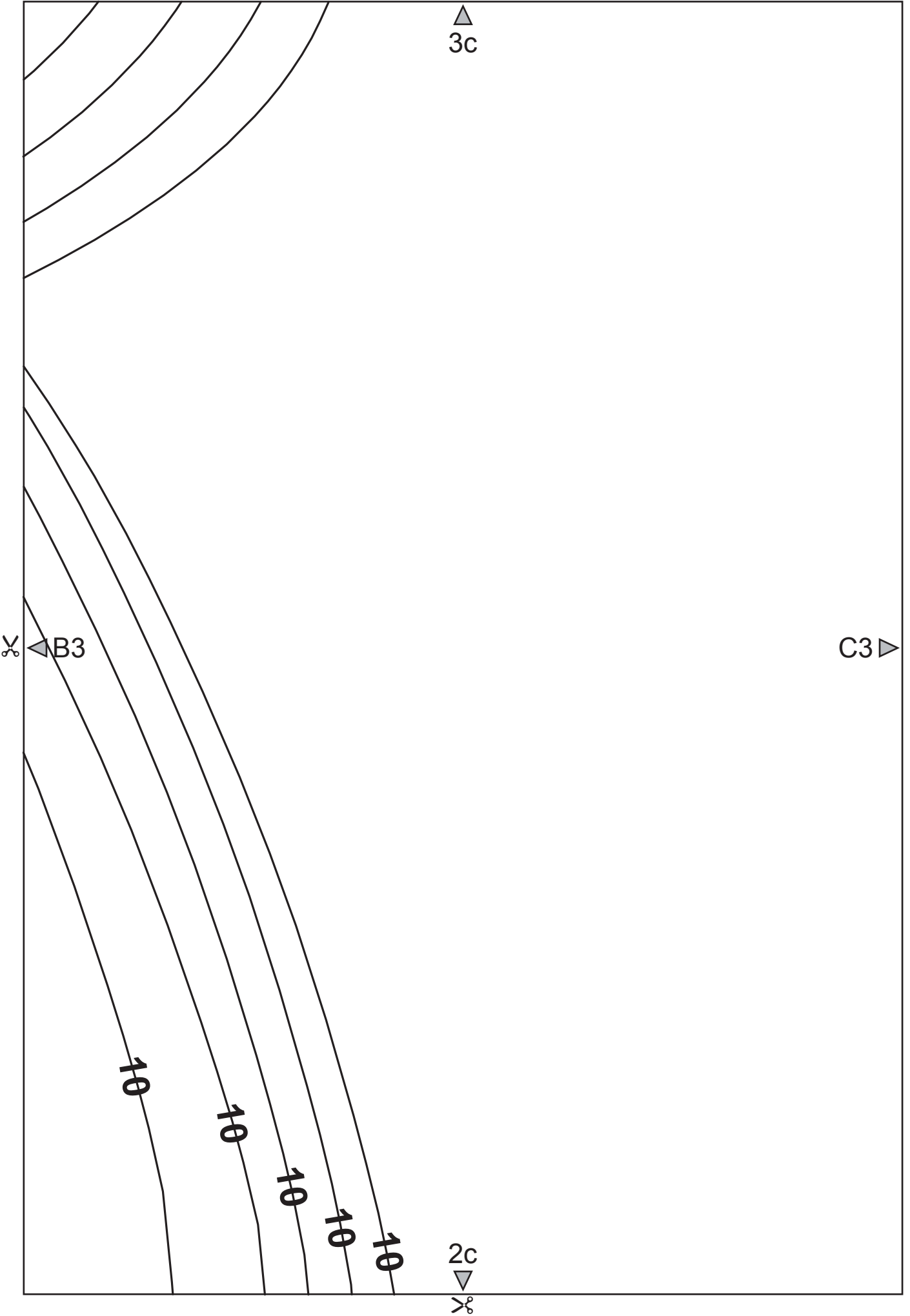

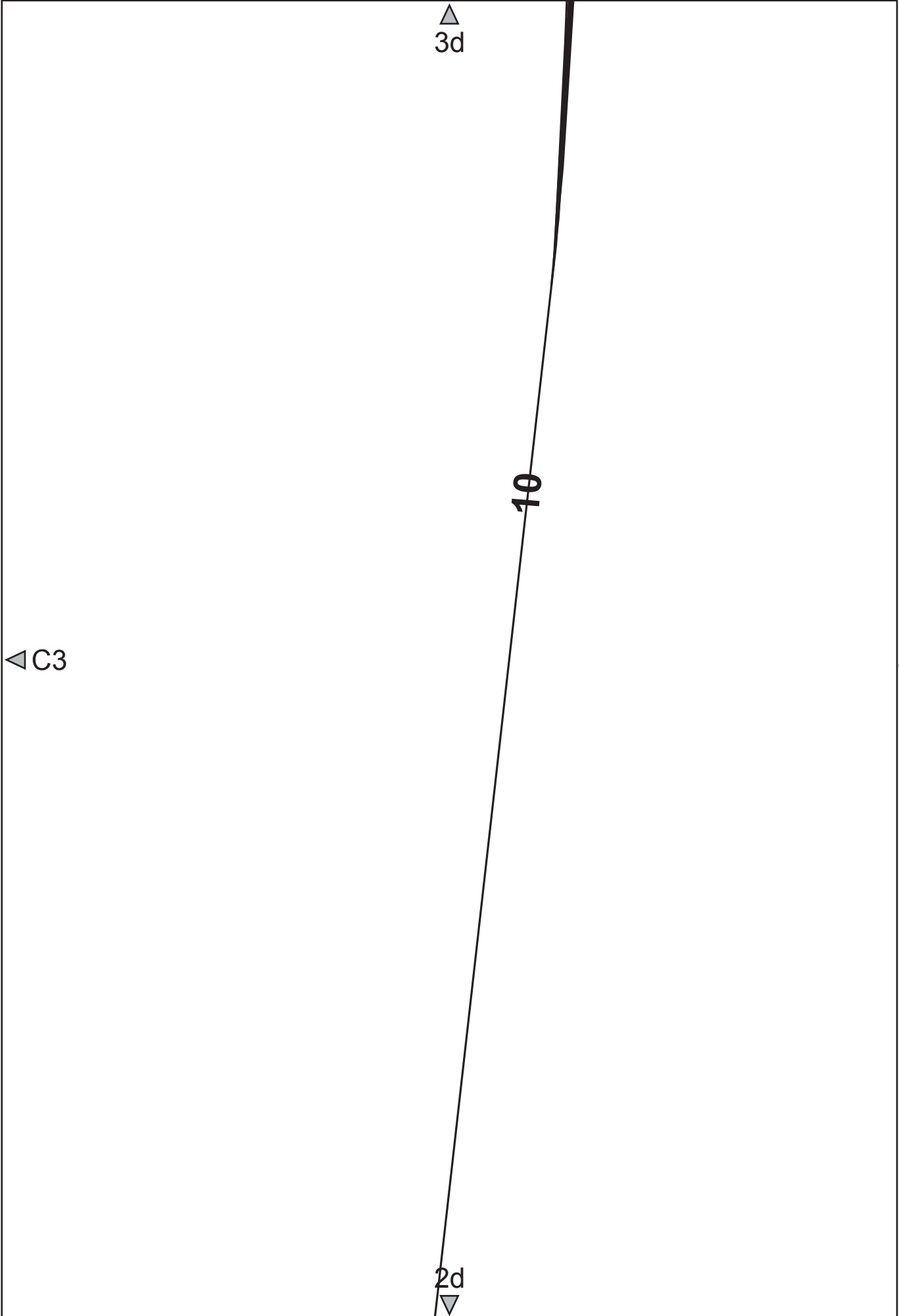



6

TX	6	
T	6	
W	6	
S	6	
SX	6	

3a



A4 ▶



MITTAKAAVAN TARKISTE

10 cm

10 cm

A4

B4

9°

9°

9°

9°

9°

3b



