

NECK GATHERING GUIDE
ARIADNE TUNIC

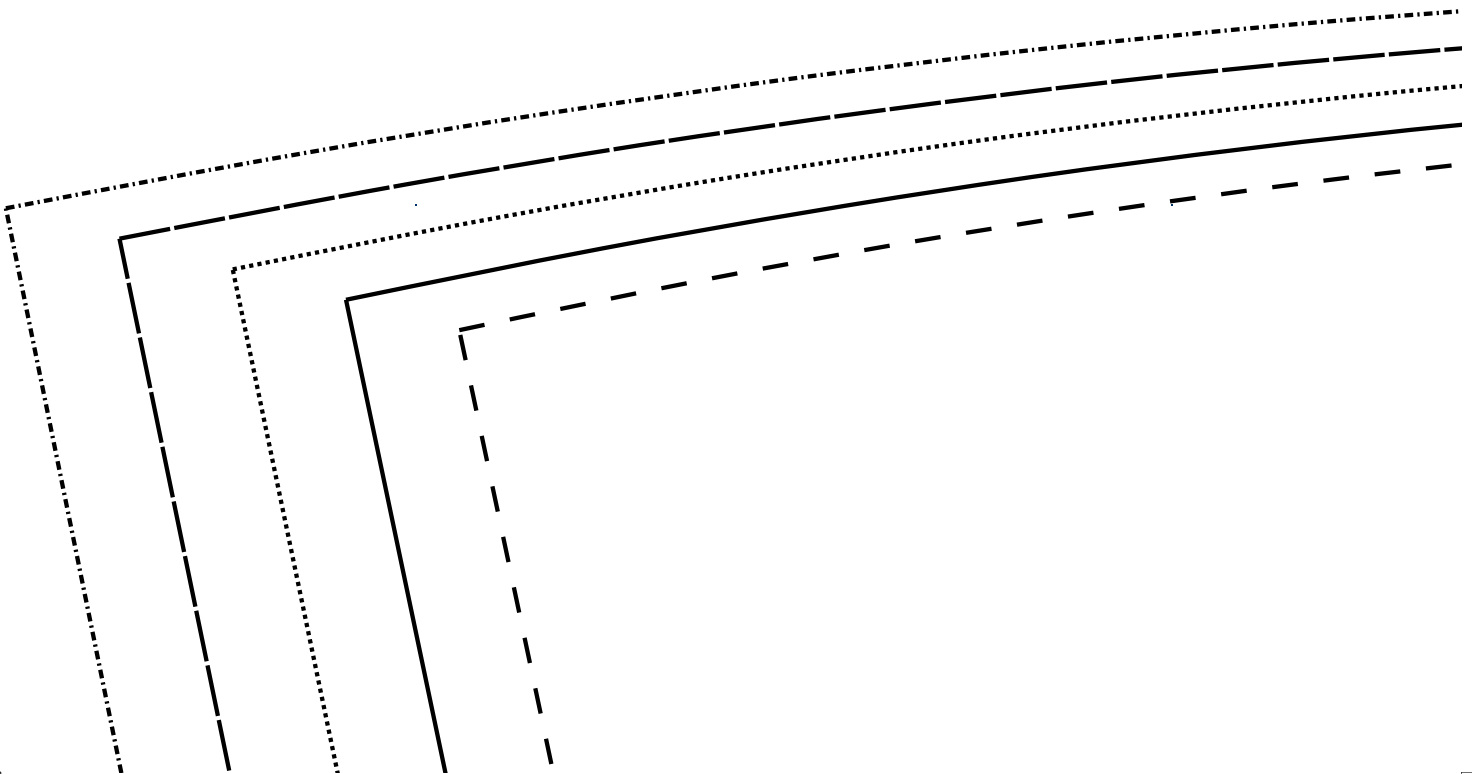

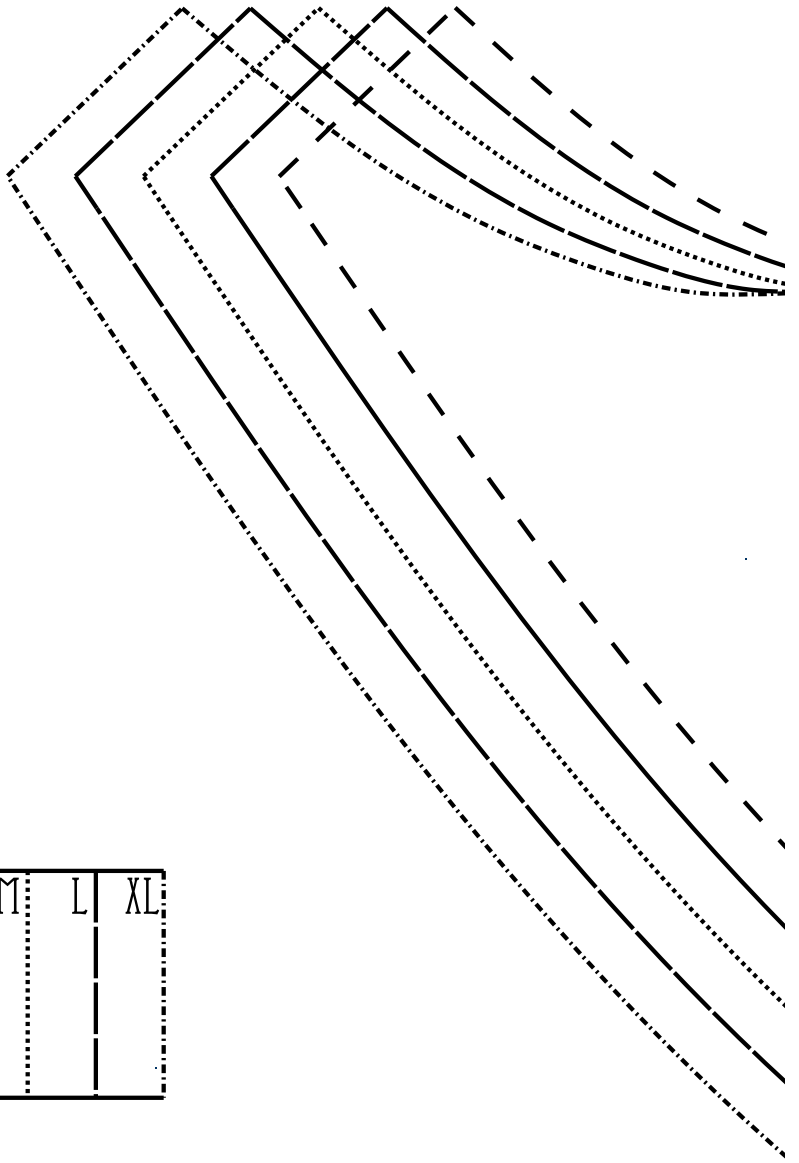

	XS	S	M	L	XL
--	----	---	---	---	----

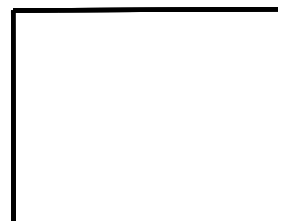
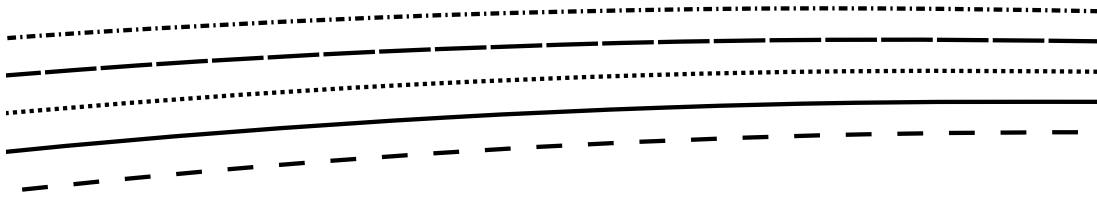

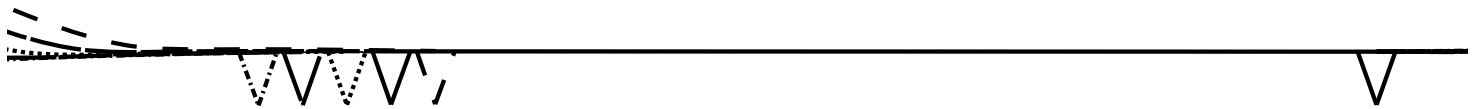

ARIADNE

A TANIT-ISIS P

WWW.TANITISIS.WOR

SLEEVE

CUT 2

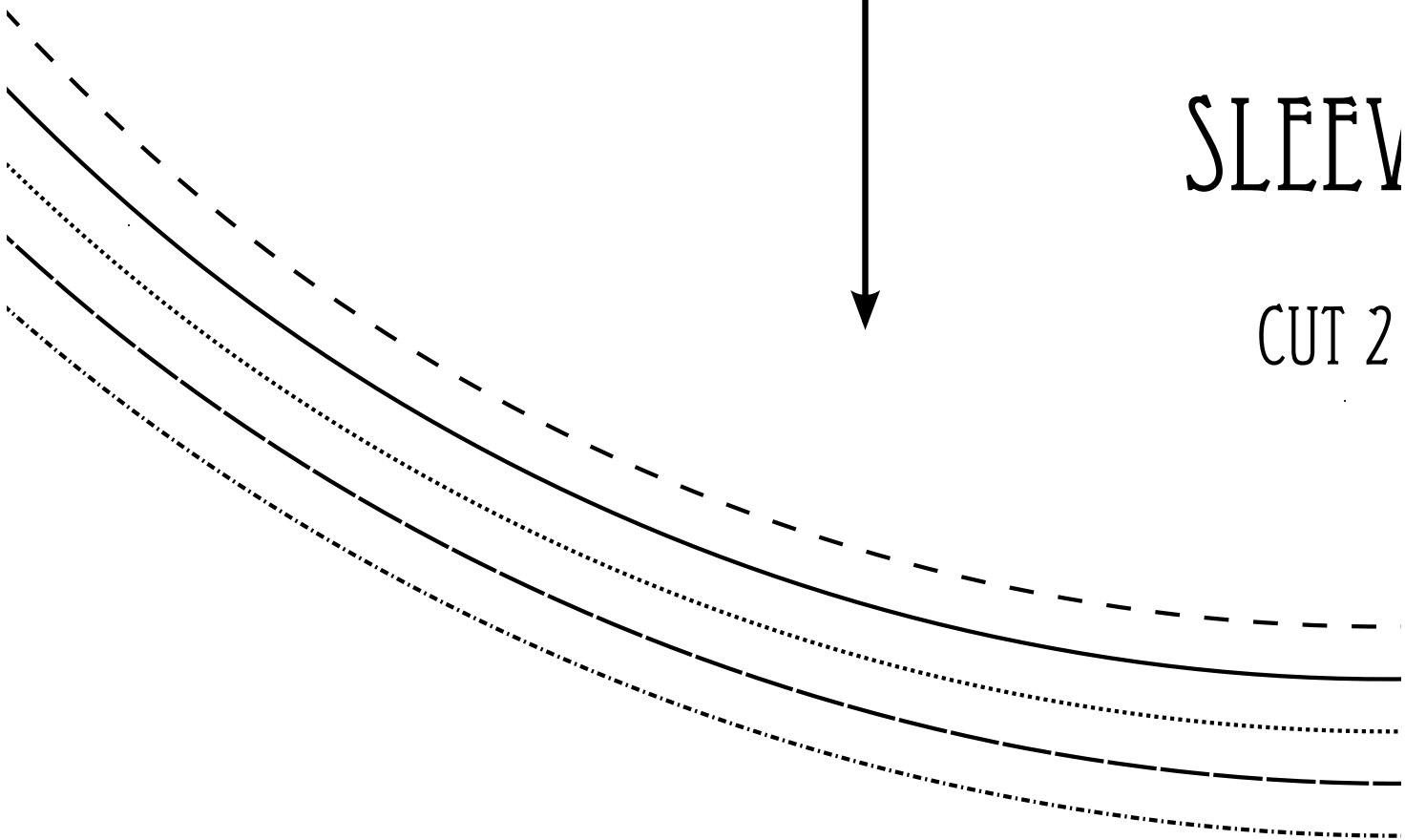

0701401100

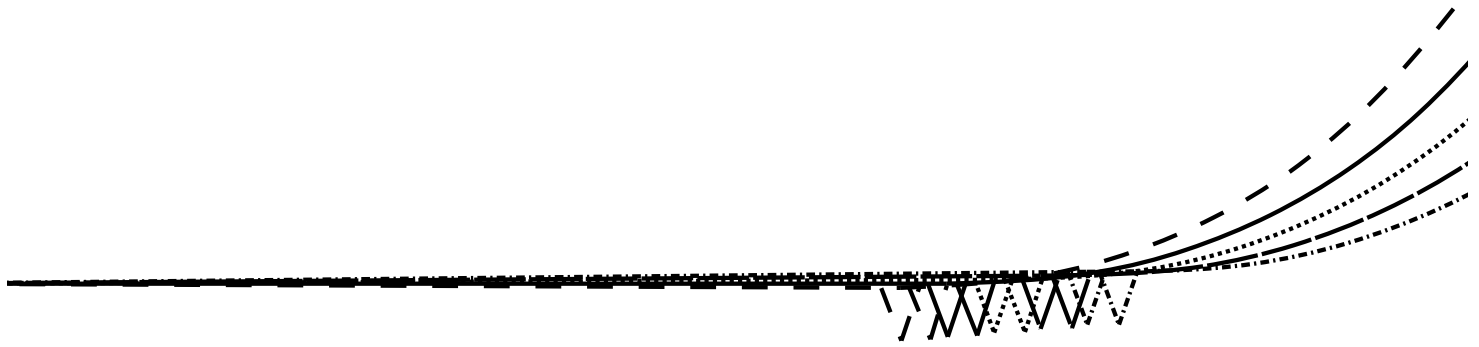

TUNIC

PATTERN

DPRESS.COM

1/E

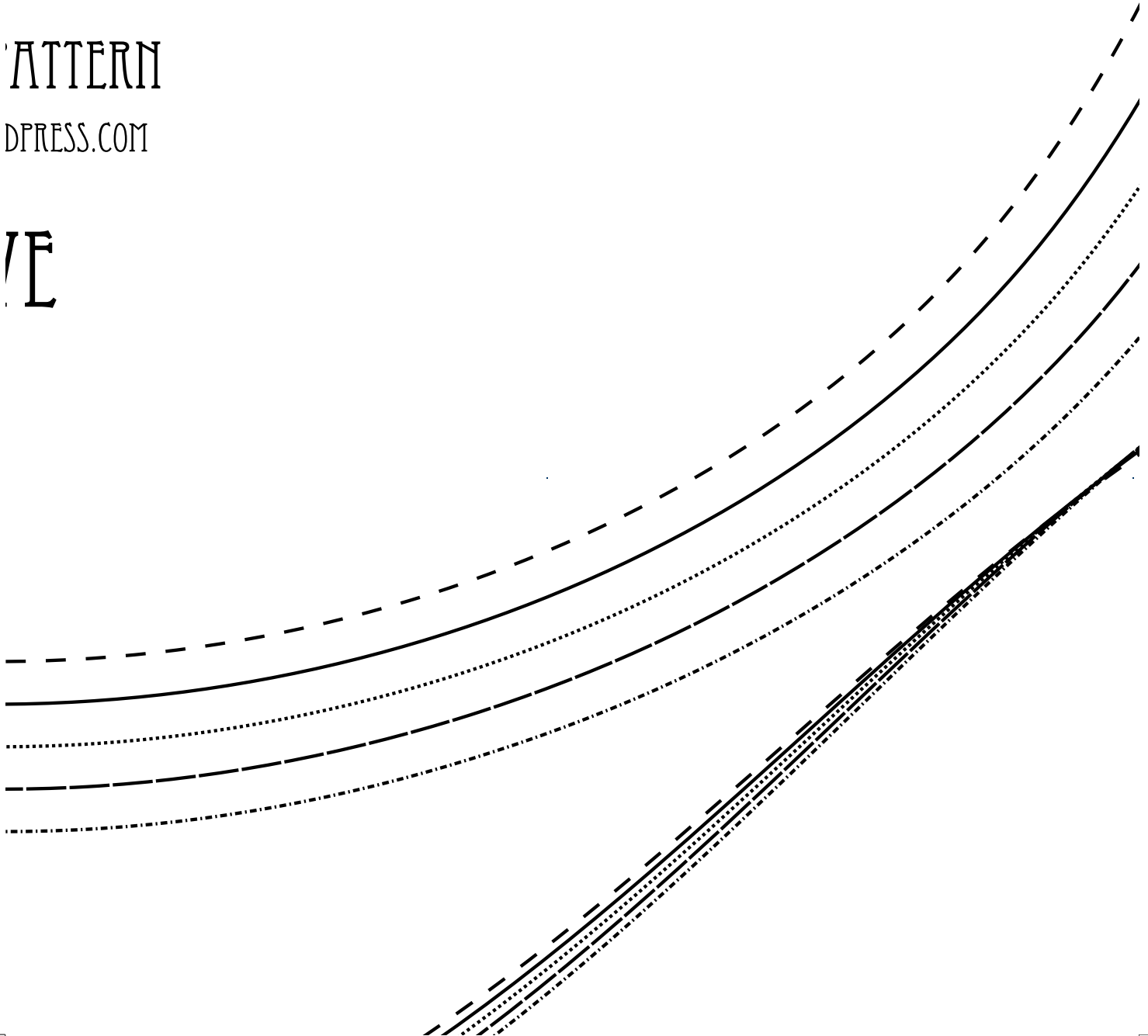

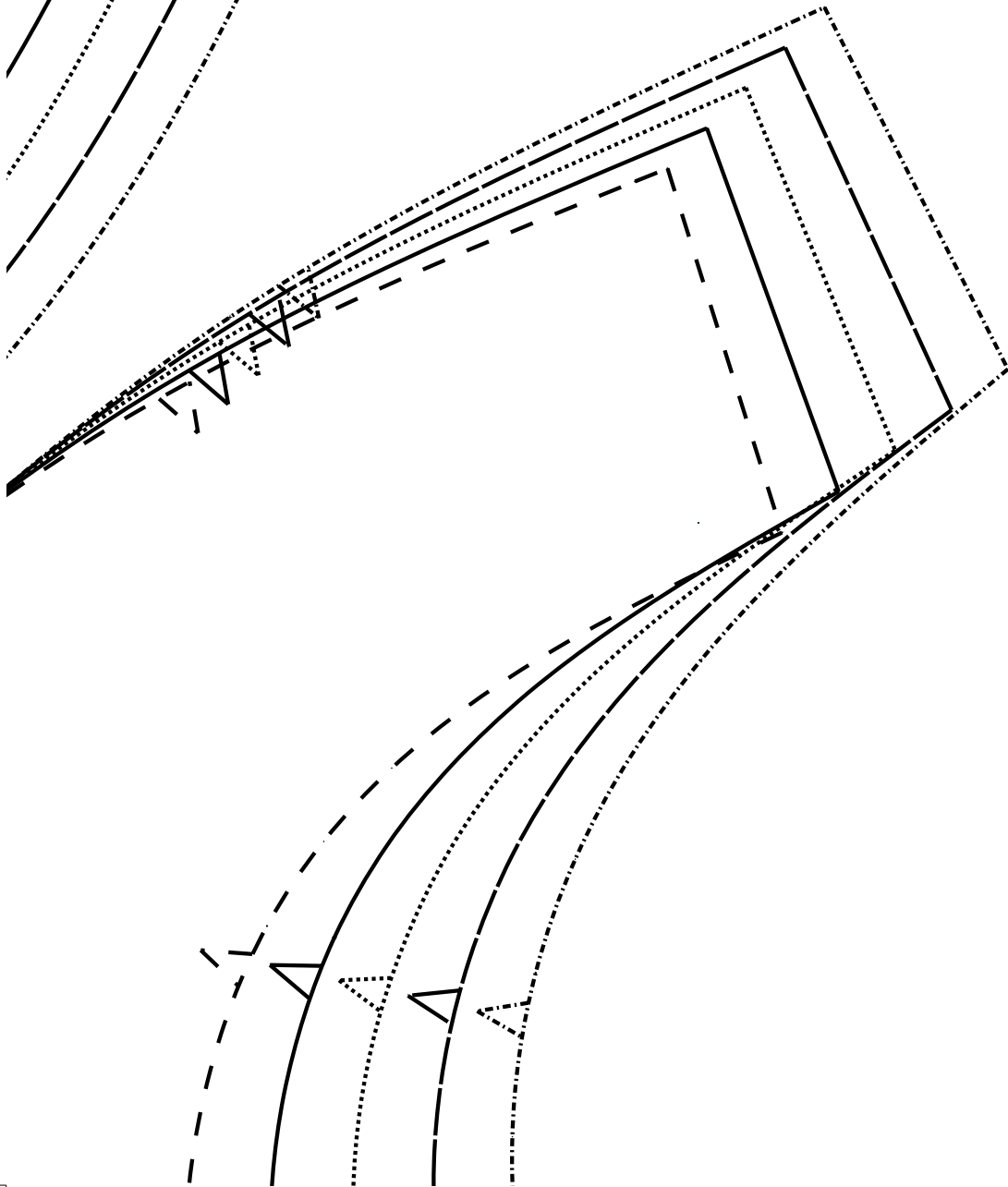
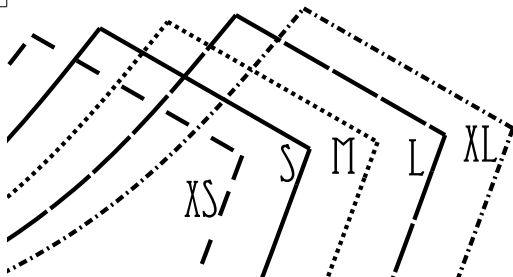

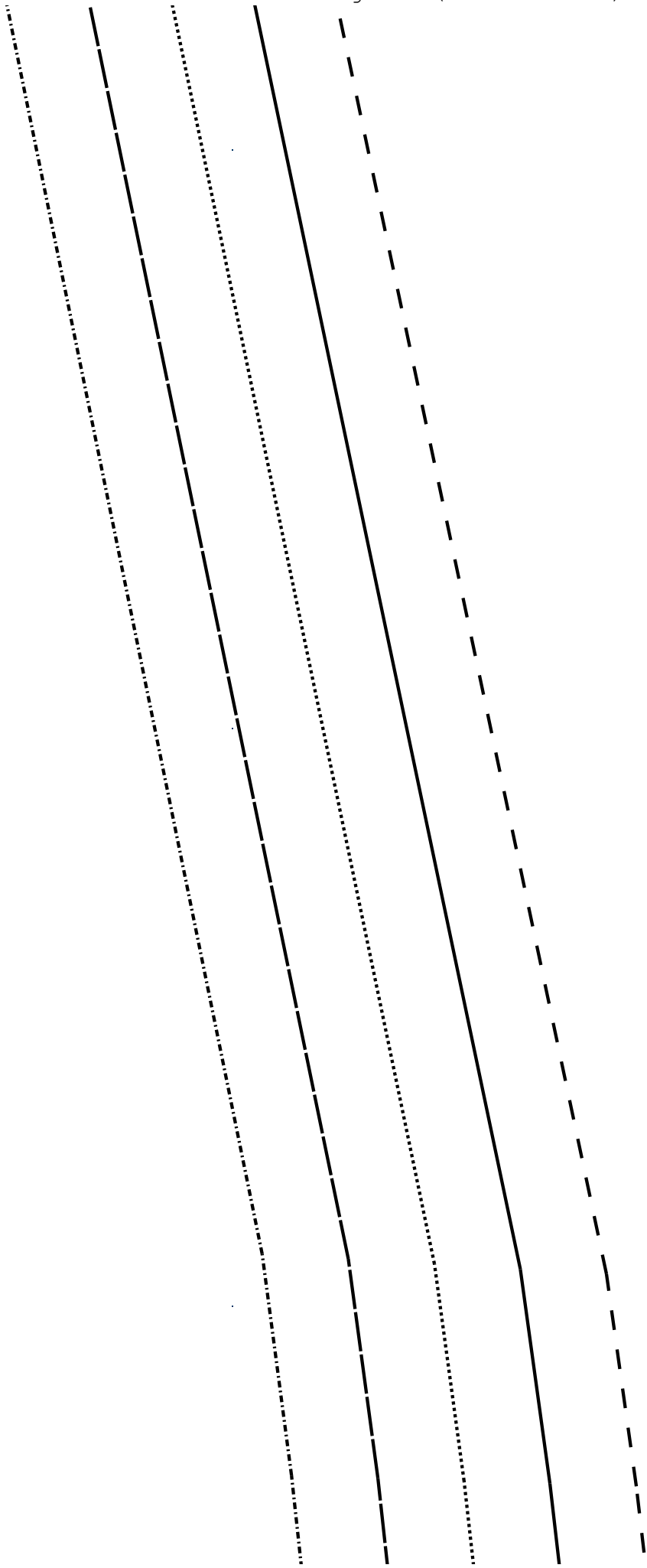

THC
RN
W0

ARIVADHE TU

A TAMIL-ISIS PATTE

WWW.TAMTISIS.WORDPRESS.C

BACK

CUT 1 ON FOLD

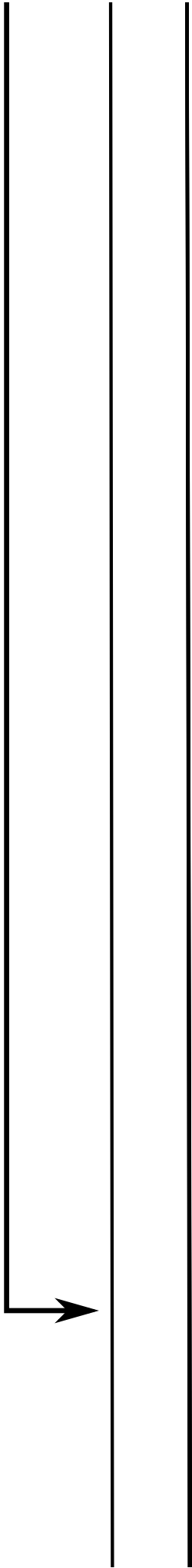

CUT 1 ON FOLD



ARIADNE TUNIC

A TANIT-ISIS PATTERN

WWW.TANITISIS.WORDPRESS.COM

BOTTOM BAND

ARIADNE TUNIC

A TANIT-ISIS PATTERN

WWW.TANITISIS.WORDPRESS.COM

FRONT



10 CM / 4"
SQUARE

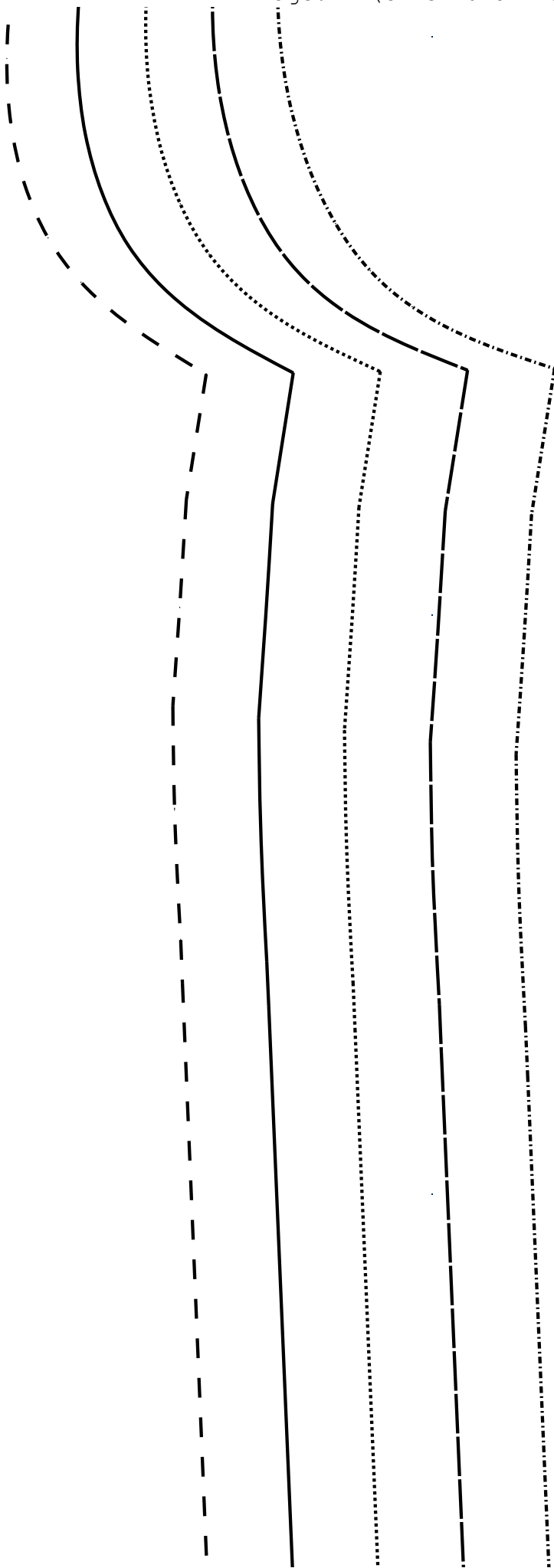

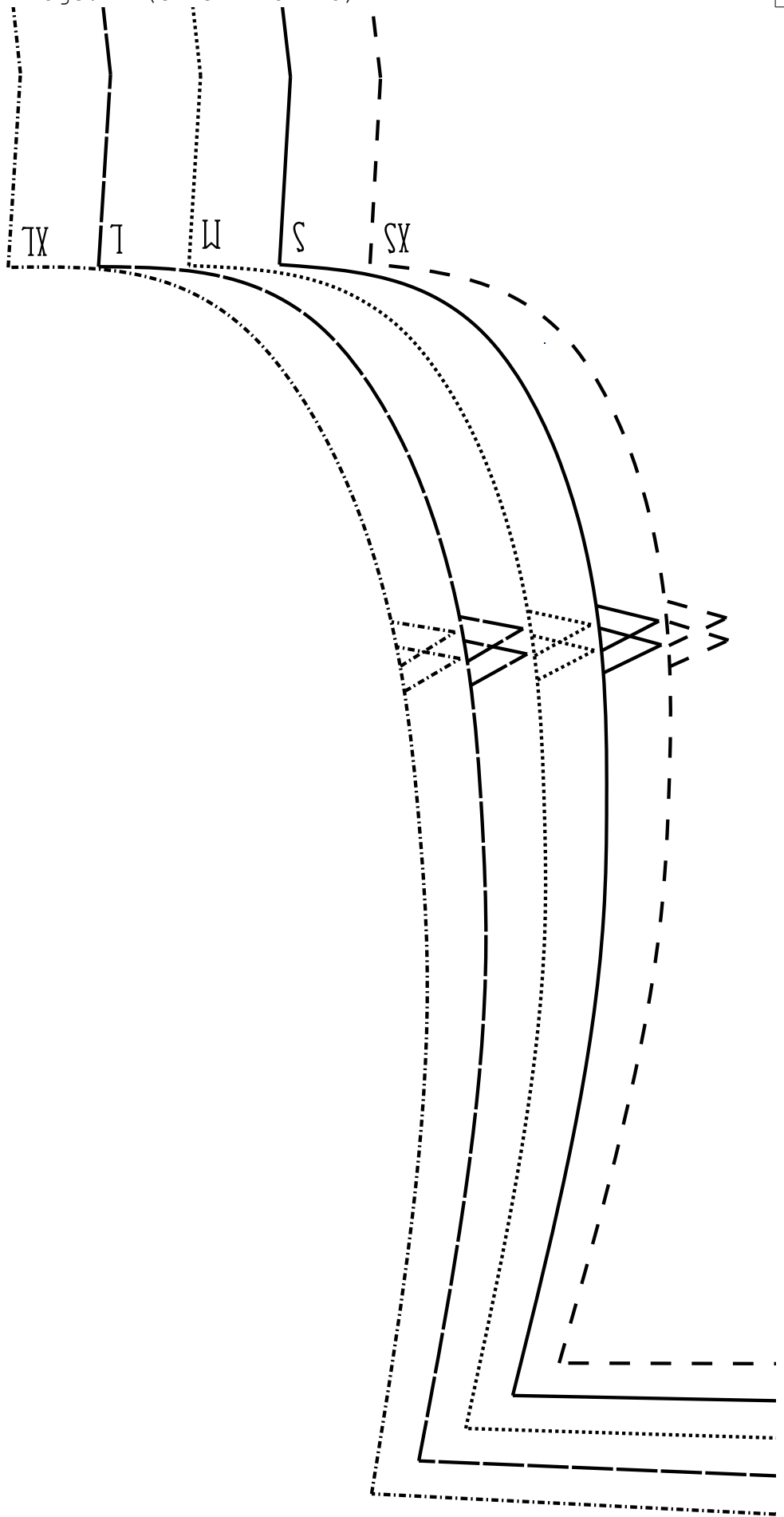

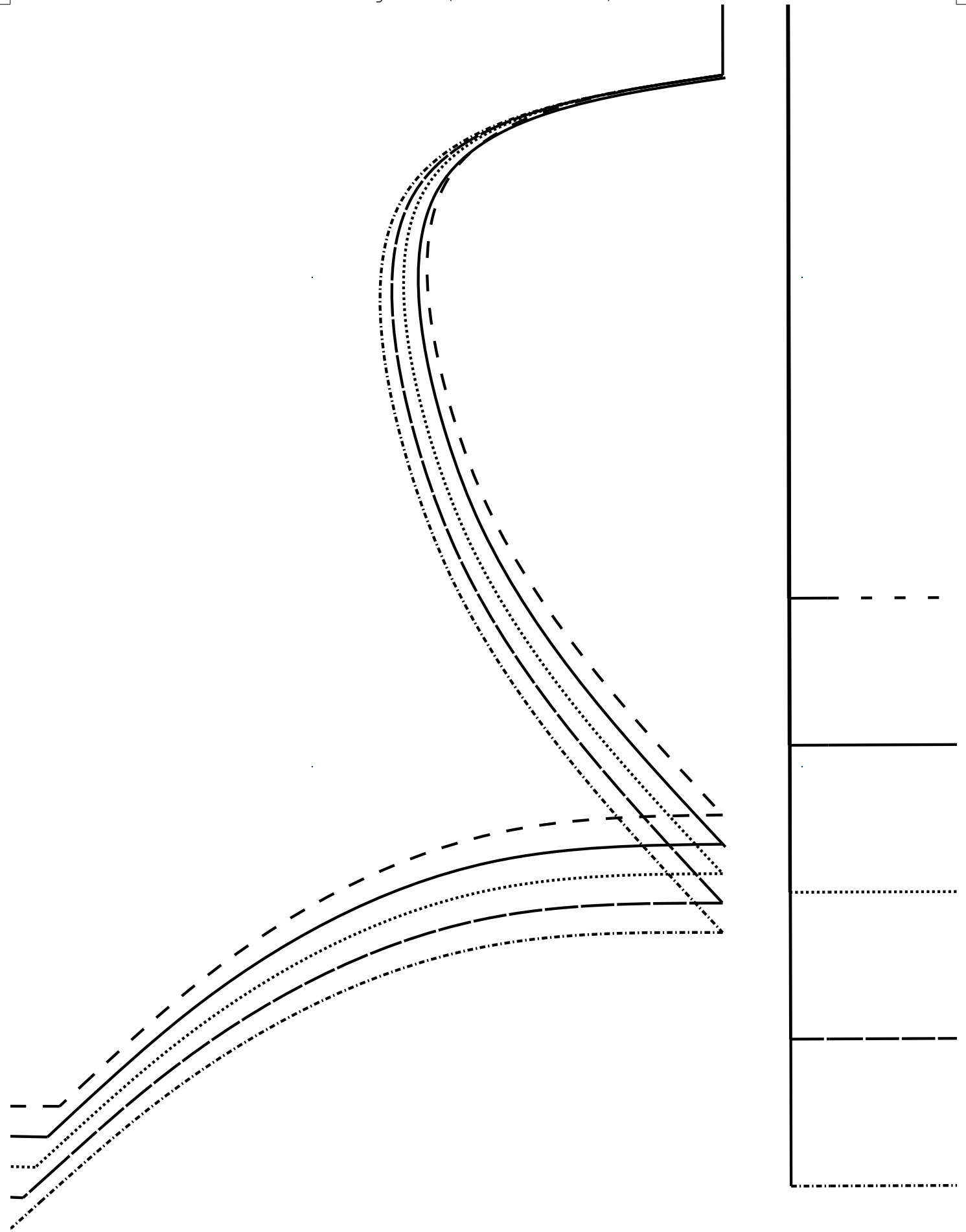

FOLD LINE

XV

S

M

L

XII



CUT 1 ON FOLD

